

Rough and medium vacuum

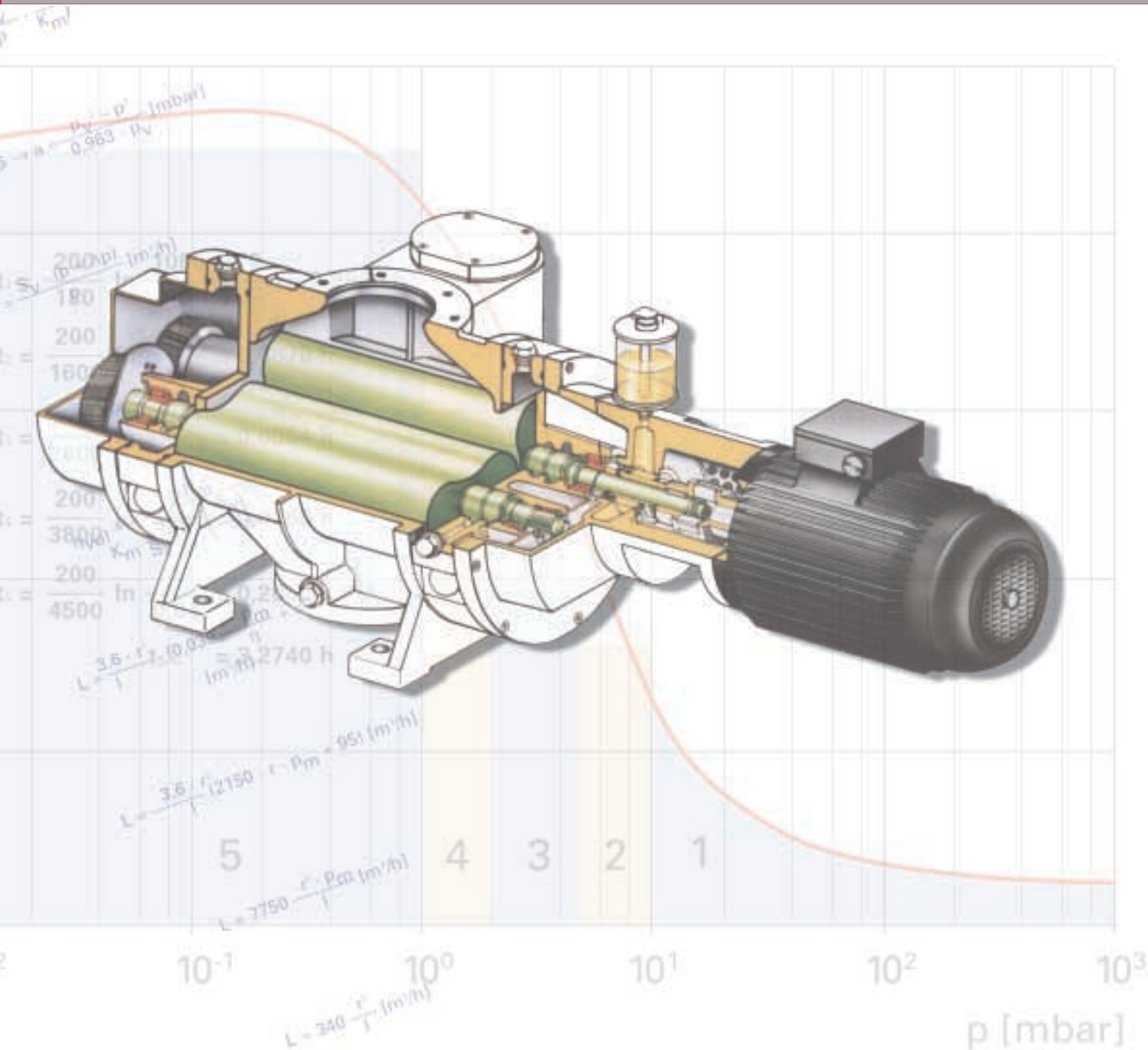

The generation of rough and medium vacuum

Generation of rough and medium vacuum

Chart

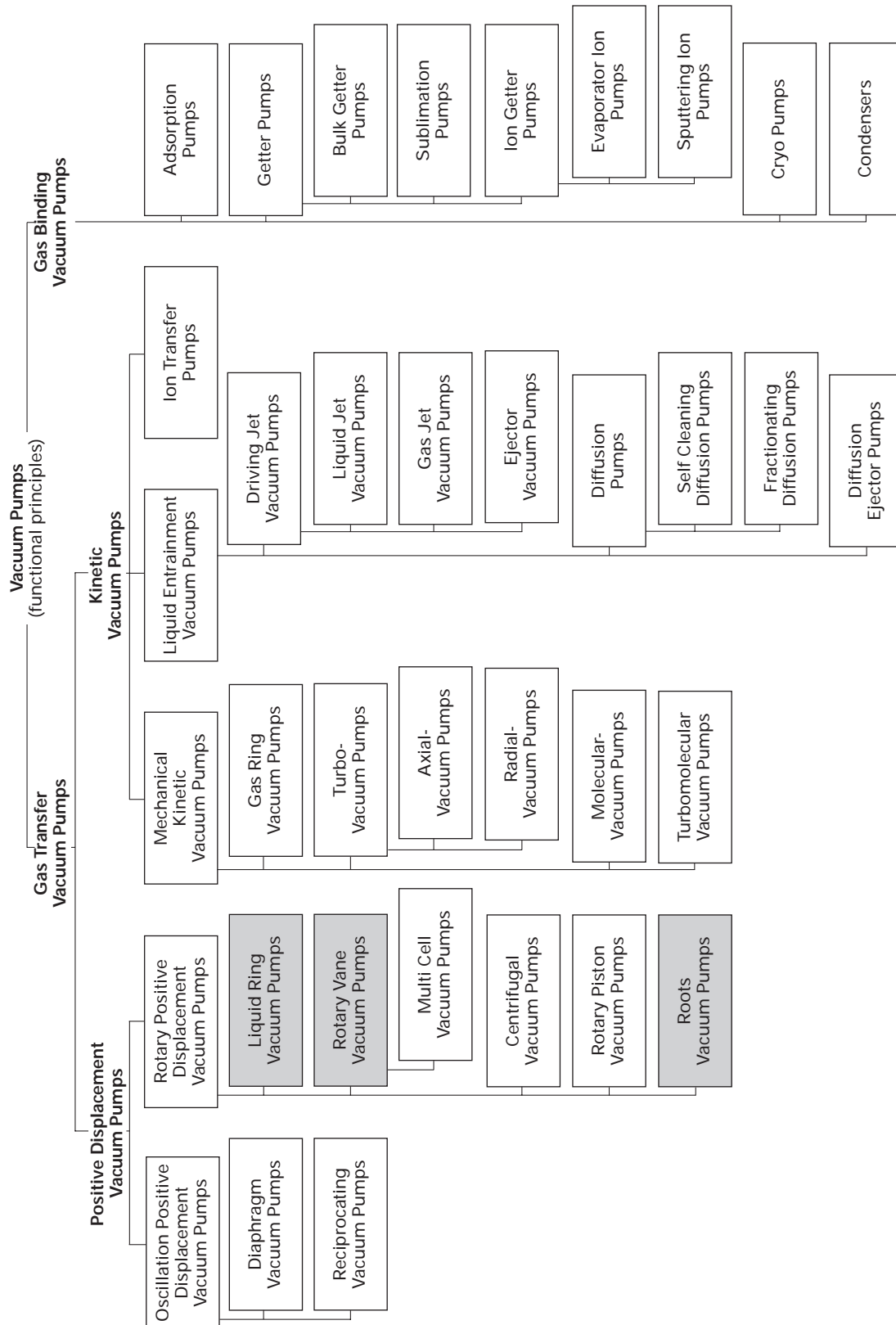

Index

	Page
1	1 Rotary Vane Vacuum Pumps
1.1	Design and Function..... 4
1.2	Accessories 9
2	Roots Vacuum Pumps
2.1	Design and Function 12
2.2	Design and Function of the Circulatory Gas Cooled Roots Vacuum Pumps (WGK) 15
2.3	Special Equipment and Accessories 17
3	Liquid Ring Vacuum Pumps
3.1	Design and Function 20
3.2	Fresh Fluid Operations 20
3.3	Combined Fluid Operations 21
3.4	Closed – Circuit Fluid Operations 21
4	Condensers
4.1	Design and Function..... 22
4.2	Condenser Calculations 23
5	Heat Exchangers
5.1	Design and Function..... 24
5.2	Heat Exchanger Calculations 25
6	Backing Pump Selection 26
7	Calculations
7.1	Power Consumption of a Roots Vacuum Pump..... 29
7.2	Volume Flow Rate of a Roots Vacuum Pumping Station 30
7.2.1	Calculating the Volume Flow Rate of a WOD 220 A Pumping Station 31
7.3	Volumetric Efficiency Rating 33
7.4	Conductance Calculations 33
7.5	Pump Down Times 36
7.6	The Influence of Leaks on Pump Down Times and End Vacuum (Leak Rate) 38
7.7	Drying Process 39
7.8	Boyle-Mariotte Law 40
7.9	Selecting a Vacuum Pumping Station 40
8	Appendix
8.1	Graphical Symbols in Vacuum Technology 44
8.2	Definition of terms in Vacuum Technology 46
8.3	Operating medium 50
8.4	Conversion Tables 51
8.5	Data on Various Substances 52
8.6	Desorption Rates on Clean Surfaces..... 54
8.7	Correction Factor a 54
8.8	Technical Data, Rotary Vane Vacuum Pumps..... 55
8.9	Technical Data, Roots Vacuum Pumps WKP 58
8.10	Technical Data, Roots Vacuum Pumping Stations 60
9	Technical Formulas 62

Rotary Vane Vacuum Pumps

1 Rotary Vane Vacuum Pumps

Single and two-stage rotary vane vacuum pumps with volume flow rates from 2.5 m³/h to 630 m³/h, with ultimate pressures of up to $< 6 \cdot 10^{-3}$ mbar are used for all vacuum processes in the rough and medium vacuum range. They can run as stand alone units or be utilized as a backing pump for vacuum pumps which do not compress against atmosphere, such as Roots vacuum pumps or turbomolecular pumps.

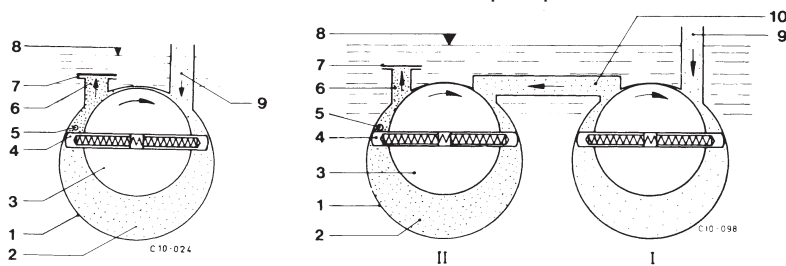

Fig. 1: Function diagram of a rotary vane vacuum pump of single- and two-stage design (Pfeiffer Vacuum GmbH).

1 Pump cylinder, 2 Compression chamber, 3 Rotor, 4 Vane, 5 Gas ballast inlet, 6 Exhaust, 7 Valve, 8 Oil level, 9 Vacuum connection, 10 Connecting passage

1.1 Design and function

The rotary vane vacuum pump is a typical example of an oil-immersed positive displacement pump.

The central component of a rotary vane vacuum pump is the pumping system. It consists of a cylinder with ports leading to the outside. These ports are used to take in and exhaust the gases to be pumped. Inside the cylinder, there is an eccentrically-arranged rotor. The vanes are fitted into slots on the rotor. The vanes, which glide along the cylinder wall, divide the available inner space into working chambers. During one full rotation of the rotor, the chamber volume increases from zero to the maximum volume and then decreases continually until it reaches the minimum value. Actual pumping is effected by the increase and decrease in size of the sickle-shaped chambers of the working space.

The decrease in chamber volume compresses the enclosed gases. The compression at approximately 200 mbar above atmospheric pressure allows for the gas pressure to be higher than the opening pressure of the exhaust valve. Rotary vane vacuum pumps are available in single and two-stage models. Two-stage pumps have a lower ultimate pressure than single-stage pumps. Rotary vane vacuum pumps can be used without problem whenever the medium to be pumped is a gas that cannot condense at the operating temperature of the pump and at atmospheric pressure. In the chemical industry, with its numerous distillation and drying processes, vapors also have to be pumped, which may condense completely or partly in the pump during the compression phase. Such condensation in the pump is always undesirable. It may speed up degradation of the operating medium or corrosion inside the pump. In addition, a deterioration of the attainable ultimate pressure must be expected when the condensate and the operating medium get mixed.

Vapors with a sufficiently high vapor pressure, which do not decompose the pump oil, can be pumped with the rotary vane vacuum pump. If, however, substances are pumped which chemically attack and decompose the pump oil or have such a low vapor pressure that condensation in the pump cannot be avoided despite gas ballast, another type of backing pump should be chosen.

Gas ballast

Rotary vane pumps have to be equipped with a device which facilitates pumping of certain quantities of process gases in chemical vacuum applications. The most feasible solution to this is the gas ballast principle. With the gas ballast method devolved by G e d e, a metered quantity of gas is admitted continuously into the

expansion chamber of the pump. Therefore, the outlet valve is open before condensation can occur. The inlet of gas, usually atmospheric air, starts immediately after the vanes fitted into the rotor shut off the expansion chamber from the intake port. This reduces the negative effect which may cause a deterioration of the ultimate pressure.

Maximum tolerable water vapor inlet pressure

(to DIN 28 426 or PNEUROP)

“The maximum tolerable water vapor inlet pressure is the highest water vapor pressure at which a vacuum pump, under normal ambient conditions (20°C, 1013 mbar), can pump and exhaust water vapor in continuous operation. It is given in mbar.”

The maximum tolerable water vapor inlet pressure changes with:

- Higher ambient temperature: the max tolerable water vapor inlet pressure rises.
- Higher pump temperature: the max. tolerable water vapor inlet pressure rises.

- Higher backpressure (on exhaust side): the max. tolerable water vapor inlet pressure drops.
- Higher permanent gas quantity with equal water vapor quantity: the max. tolerable water vapor inlet pressure rises.
- Reduced gas ballast quantity: the max. tolerable water vapor inlet pressure drops.
- Increasing water vapor content in the gas ballast: the max. tolerable water vapor inlet pressure drops.

Assuming a ratio of gas ballast volume to volume flow rate of 10%, this results in the max. tolerable vapor inlet pressures given in table 1 for different operating temperatures. The opening pressure of the outlet valve in this example is 1200 mbar. It can be clearly seen that the max. tolerable vapor inlet pressure depends on the operating temperature to a very high degree. High max. tolerable vapor inlet pressures can only be reached with operating pressures which are clearly above 70°C. The upper limit temperatures are determined by the oil temperature and seal materials used.

Rotary Vane Vacuum Pumps

The effects of the gas ballast on the maximum tolerable vapor inlet pressure can be shown by the fundamental principles of thermodynamics. According to these, this pressure can be calculated as follows:

$$p_{w0} = \frac{B}{S} \cdot \frac{1333 (p_s - p_a)}{1333 - p_s} \text{ [mbar]}$$

Equation 1

Max. tolerable inlet pressures for other vapors are defined in DIN 28 426.

Generally, the following equation is used for calculation:

$$p_D = \frac{B}{S} \cdot \frac{p_v (p_{SD} - p_{AD})}{p_v - p_{SD}} + \frac{p_{SD} - p_L}{p_v - p_{SD}} \text{ [mbar]}$$

Equation 2

$\frac{q_{p,v}}{S}$
Ratio of gas ballast inlet volume to volume flow rate of backing pump

p_{w0} (mbar)
Maximum tolerable water vapor inlet pressure PNEUROP

B (m³/h)
Gas ballast volume

S (m³/h)
The nominal volume flow

p_s (mbar)
Saturation vapor pressure of the water vapor pumped at the pump's operating temperature

p_a (mbar)
Water vapor partial pressure of atmospheric air (value in practical operation $p_a = 13$ mbar)

p_v (mbar)
Pressure in exhaust port of the pump

p_{SD} (mbar)
Saturation pressure of vapour component at pump operating temperature

p_{AD} (mbar)
Partial pressure of vaporized substance in atmospheric air

p_L (mbar)
Permanent gas partial pressure at intake port

p_D (mbar)
Maximum tolerable vapor inlet pressure

T_B (°C)
Operating temperature of the pump

T_S (°C)
Boiling temperature of the substance pumped off at the pressure in the exhaust port of the pump

Operating temperature (°C)	$\frac{q_{p,v}}{S}$	Max. tolerable water vapor inlet pressure (mbar)	Max. tolerable styrene vapor inlet pressure (mbar)
50	0,1	10	3
60	0,1	18	5
70	0,1	34	7
80	0,1	63	12
90	0,1	134	18

Table 1

Medium to be pumped	Temperature	Condensation	Result
Soluble in operating medium	$T_B > T_S$	no	Oil dilution
	$T_B < T_S$	yes	Oil dilution
Not soluble in operating medium	$T_B > T_S$	no	—
	$T_B < T_S$	yes	Forming an emulsion

Table 2

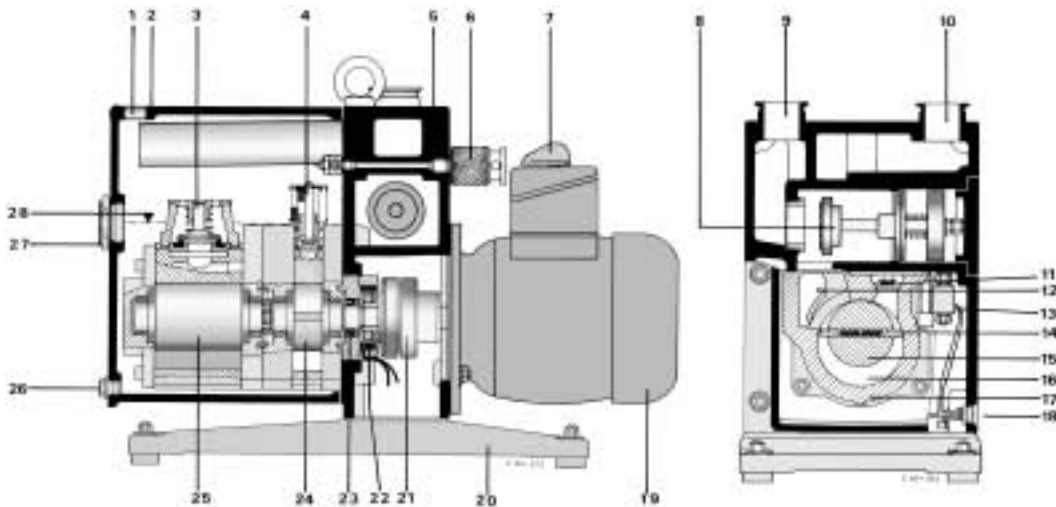

Fig. 2 Section through a two-stage rotary vane vacuum pump (Pfeiffer Vacuum GmbH).

- | | |
|--|--------------------------|
| 1 Oil filling plug | 15 Rotor |
| 2 Cap | 16 Working chamber |
| 3 Pressure relief valve | 17 Pump cylinder |
| 4 Pump valve | 18 Monitoring connection |
| 5 Support stand | 19 Motor |
| 6 Gas ballast valve | 20 Base plate |
| 7 On/Off switch with motor protection switch | 21 Coupling |
| 8 High vacuum safety valve | 22 D.C. generator |
| 9 Vacuum connection | 23 Radial shaft seal |
| 10 Exhaust connection | 24 Pumping stage II |
| 11 Pump valve | 25 Pumping stage I |
| 12 Intake channel | 26 Oil drain plug |
| 13 Solenoid valve | 27 Sight glass |
| 14 Vane | 28 Oil level |

Drive

Depending on their size, the pumps are equipped with single or three-phase motors. The three-phase motors have PTC resistor temperature sensors fitted into the windings. To utilize these temperature sensors, a tripping device is required. All motors have the starting torque required by PNEUROP for cold starting at 12°C.

Rotary Vane Vacuum Pumps

Magnetic-coupled rotary vane vacuum pumps

The new drive concept - "the integrated magnetic coupling" - is the latest innovation within the rotary vane pump market. The separation of the rotor and motor shaft eliminates the problem of the radial shaft seal providing a hermetically sealed pump. The wear-free drive prevents leaks (no contamination from leaking oil), minimizes maintenance and increases the MTTF (meantime to failure): providing low cost of ownership. (Figure 3)

High-vacuum safety valve

During intentional and unintentional shutdowns, an integrated high-vacuum safety valve with a leak rate of $<1 \cdot 10^{-5}$ mbar l/s immediately separates the pump from the vacuum chambers and vents the pump. The HV safety valve responds as soon as the nominal rotation speed of the pump falls below 10%. It prevents the rise of oil to the vacuum chambers and vents the pumping system with the pumped gas. It delays opening so that a pressure compensation is achieved between the pump and vacuum chambers. Depending on the pump type, the high-vacuum safety valve is controlled by either the DC generator on the solenoid valve or the oil pressure.

Silencer

The silencer provides a quiet running pump. For this, small quantities of gas are continuously admitted to the oil circuit. The silencer has been designed so that only the pumped gas is fed into the oil circuit. This prevents any contamination of expensive or sensitive gases by atmospheric air. The silencing device is accessible from outside. If necessary, it can be readjusted while the pump is running.

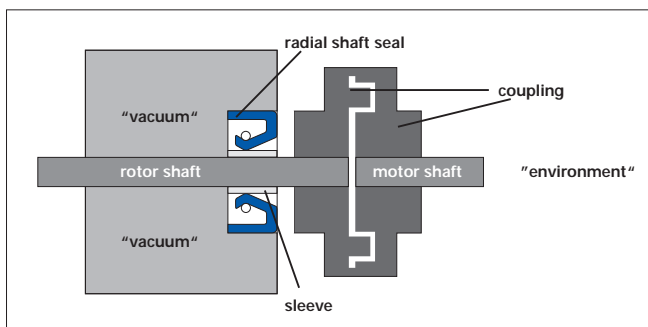
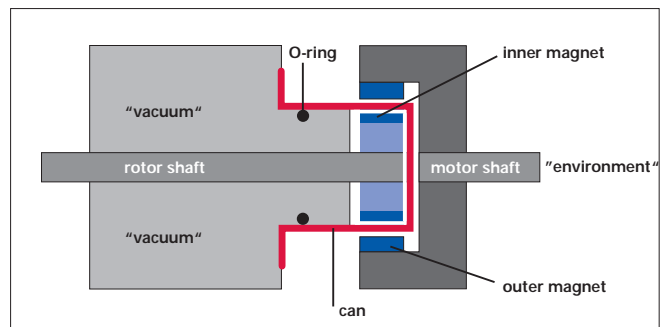

Fig. 3 Traditional drive concept



New, wear free drive concept with magnetic coupling

Fig. 4

Accessories

- FAK – Activated carbon filter
- FBL – Clay filter
- KAS – Condensate separator
- KLF – Cold trap
- KWK – Crystallization cooler
- ONF – Oil mist filter

- ORF – Oil return device
- STP – Dust separator
- STR – Dust separator
- STZ – Dust separator
- URB – Catalyzer trap
- ZFH – Heating rod
- ZFO – Zeolite trap

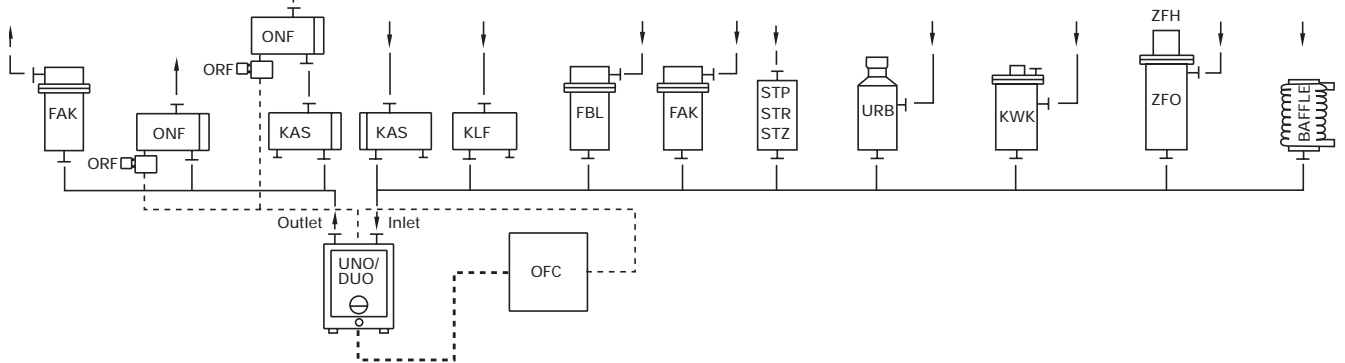

1.2 Accessories

Separators

Condensate separator (KAS)

Condensates may form in the intake and exhaust lines of vacuum systems when vapors are pumped off. To protect the pump from such condensates, it is recommended to install a condensate separator both in the intake line and in the exhaust line.

Oil mist filter (ONF)

Oil mist filters are fitted to the exhaust port of rotary vane vacuum pumps. They prevent contamination of the air by oil mists which, depending on the working pressure, are exhausted by the pumps in large or small quantities. The oil mist filter consists of a cylindrical filter element of porous ceramic material and an aluminum housing, with oil container.

Oil return device (ORF)

The ORF, in combination with the oil mist filter, collects and returns oil back into the pump. It helps to reduce the operating costs, especially when special oils are used.

Dust separator (STP, STR, STZ)

A dust separator is required if the process generates dust particles that can reach the pump.

Crystallization cooler (KWK)

This cooler is used for special processes in semiconductor production, e.g. LPCVD. It can also be used to cool hot gases and vapors to temperatures which are not detrimental to the rotary vane vacuum pump.

Rotary Vane Vacuum Pumps

Adsorption trap

Reduces backstreaming of oil.

The ultimate pressure and residual gas compositions are strongly influenced by hydrocarbons streaming back from rotary vane vacuum pumps. Therefore, traps are installed on the backing pressure side of high vacuum pumps to obtain a hydrocarbon-free vacuum in the process chamber.

Zeolite (ZFO)

The zeolite trap prevents backstreaming of hydrocarbons from rotary vane vacuum pumps to downstream high vacuum components by adsorption. The adsorbent can be regenerated by baking out at 300°C.

The regeneration intervals depend on the process.

Catalyzer trap (URB)

The catalyzer trap prevents backstreaming of hydrocarbons on single or two-stage rotary vane vacuum pumps by catalytic combustion. The oxygen supplied to the trap from periodic venting of the process chamber is sufficient for self cleaning of the trap. The regeneration intervals are therefore, independent of the process. Water cooling is required if the trap is fitted directly to the intake port and if it is used with single-stage rotary vane vacuum pumps.

Cold trap (KLF)

The cold trap prevents backstreaming of hydrocarbons from single or two-stage rotary vane vacuum pumps by condensation. The cold trap also provides effective protection for the rotary vane vacuum pump when aggressive media are pumped. It can be operated with different coolants, e.g. LN₂ or CO₂. The regeneration intervals and the coolant consumption depend on the process.

Filters

Protects the rotary vane vacuum pump and the operating medium.

The vapors produced by certain processes can attack the operating media and decrease the life-time of the pump. The filters available have high adsorption capacity and are well suited for such vapor producing processes.

Activated carbon filter (FAK)

This filter is used if H₂S, HCN, Hg, NH₃, SO₂ gases and solvent, acid and alkaline vapors are present. The activated carbon filters are delivered with one filling. The activated carbon filling can be exchanged. The service life of the filter filling depends on the process.

Clay filter (FBL)

The clay filter protects the rotary vane vacuum pump and the operating medium by adsorbing organic vapors. The clay filling can be exchanged. The service life of the filter filling depends on the process. This filter is used for peroxides, hydroperoxides and polycondensates in the petrochemical, plastics and resin chemical industries.

Oil Filters

Chemical oil filter (OFC)

The chemical oil filter is installed within the oil flow path of rotary vane vacuum pumps. The oil filter prevents wear on the pump and increases the life of the oil by filtering out dust and particles and by absorbing corrosive substances from the pump oil.



Magnetic coupled
Rotary Vane Vacuum Pump



Rotary Vane Vacuum Pumps DuoLine

2 Roots Vacuum Pumps (WKP)

Roots Vacuum Pump

In principle, the Roots vacuum pump represents the ideal, dry operating vacuum pump. Roots vacuum pumps, in conjunction with backing pumps such as rotary vane vacuum pumps and gas-cooled Roots vacuum pumps, are used for all applications involving the rough to medium vacuum range where large volume flow rates are required.

Circulatory gas cooled Roots Vacuum Pumps

Circulatory gas cooled Roots vacuum pumps of the series WGK differ from the non-cooled series WKP in that they can be operated without backing pumps in the pressure range 130 to 1013 mbar. Since no backing pumps are required, the pumped medium is not contaminated by operating fluids and pollutants are not released into the drainage system. When combined with additional Roots vacuum pumps, a final pressure in the medium vacuum range is attainable.

2.1 Design and Function of Roots Vacuum Pumps

The Roots Vacuum Pump is a positive displacement pump developed for vacuum operations. It has a high compression ratio coupled with a large volume flow rate in the pressure range 50 mbar to $1 \cdot 10^{-3}$ mbar. The pumps work on a 100 year old Roots principle whereby two synchronous rotors turn, without contact, in a housing.

Pumping occurs via two figure eight shaped counter-rotating rotors synchronized by means of a pair of gears which are fitted to the ends of the rotor shafts. Pumping chambers are formed by the housing while the two rotors seal against each other without contact. The Roots vacuum pump can operate at high rotational speeds (1500-3000 rpm) because no friction takes place in the pumping chamber. The lubrication is limited to the gear and bearing housings which are separated from the pumping chamber. The absence of reciprocating parts allows perfect dynamic balancing so that despite high rotational speeds the Roots vacuum pump runs very quietly.

One of the outstanding features of the Roots vacuum pump is, relative to its size, the large volume flow rate.

However, above certain differential pressures between intake and discharge side, thermal overloading can arise if an effective compression ratio of 1:2 is exceeded. This can lead to seizing and possible destruction of the pump.

Depending on the process involved, the dry compressing Roots vacuum pump can be combined with various backing pumps, e.g. rotary vane vacuum pumps, liquid ring vacuum pumps, dry backing pumps, multi-stage Roots vacuum pumps or, for special applications, an in-line series of circulatory gas cooled Roots vacuum pumps.

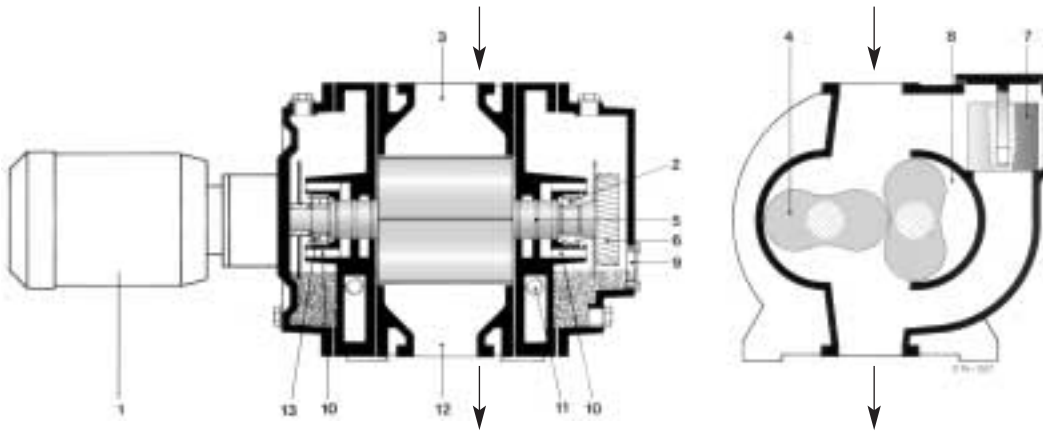

Fig. 5 Sectional representation of a Roots vacuum pump (WKP 500 A, Pfeiffer Vacuum GmbH).

- | | | |
|---------------------|--------------------|-------------------------|
| 1 Motor | 6 Gears | 11 Temperature control |
| 2 Moveable bearing | 7 Overflow valve | 12 Discharge connection |
| 3 Intake connection | 8 Pumping chamber | 13 Fixed bearing |
| 4 Roots vacuum pump | 9 Sight glass | |
| 5 Labyrinth seal | 10 Oil return line | |

The drawing shows a longitudinal view of a Roots vacuum pump. The direction of delivery is vertical, from top to bottom, so that any particles suspended in the suction stream can be carried out of the pump.

The rotor shaft bearings are fitted on both ends: On one end as a fixed bearing and on the other with a moveable inner ring to allow for the unequal expansion between the housing and rotors. The bearings are

lubricated by immersing gears and splash rings into oil reservoirs. Labyrinth sealing system, centrifugal rings and oil return channels, fitted between bearing and pumping chamber, prevent the lubricating oil from entering into the pumping chamber. In the standard design, the extension of the drive shaft to the outside is sealed with oil lubricated radial shaft seals. The radial shaft seals run on a special bushing to protect the shaft.

Roots Vacuum Pumps

Overflow valve

The overflow valve is connected to the intake and discharge lines of the pump via conduits. A gravity type plate valve which is adjusted to the permissible pressure differential of the pump opens when the pressure differential is exceeded and allows, depending on the volume of gas, a greater or lesser part of the sucked in gas to backstream from the discharge to the

intake side. This arrangement enables the Roots vacuum pump to cut in at atmospheric pressure and protect both the pump and its motor from thermal overloading. Another advantage is fast pump down times. Since the Roots vacuum pump can start at atmosphere with the backing pump, a larger volume flow rate is possible versus just having the backing pump operate by itself.

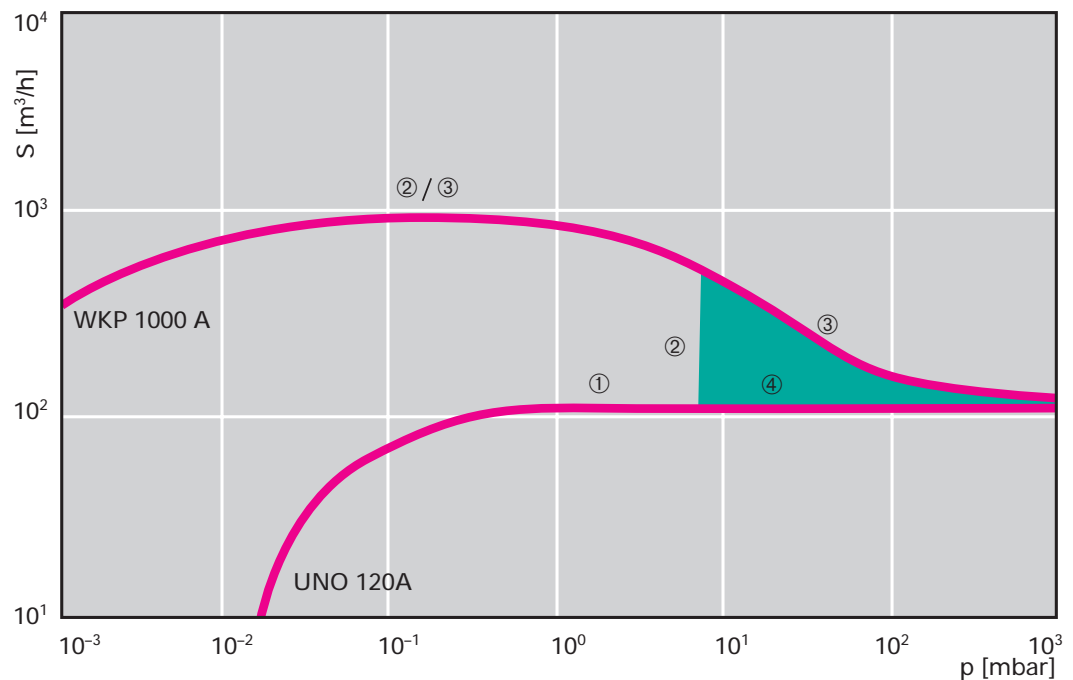

Fig. 6

- 1) Volume flow rate curve of the backing pump
- 2) Volume flow rate curve of the Roots vacuum pump (cutting in at 7 mbar)
- 3) Volume flow rate curve of the Roots vacuum pump with overflow valve
- 4) Gain in volume flow rate through 3

Vacuum Pumping Station WOD 900 A (Pfeiffer Vacuum GmbH)
comprising of a WKP 1000 A and UNO 120.

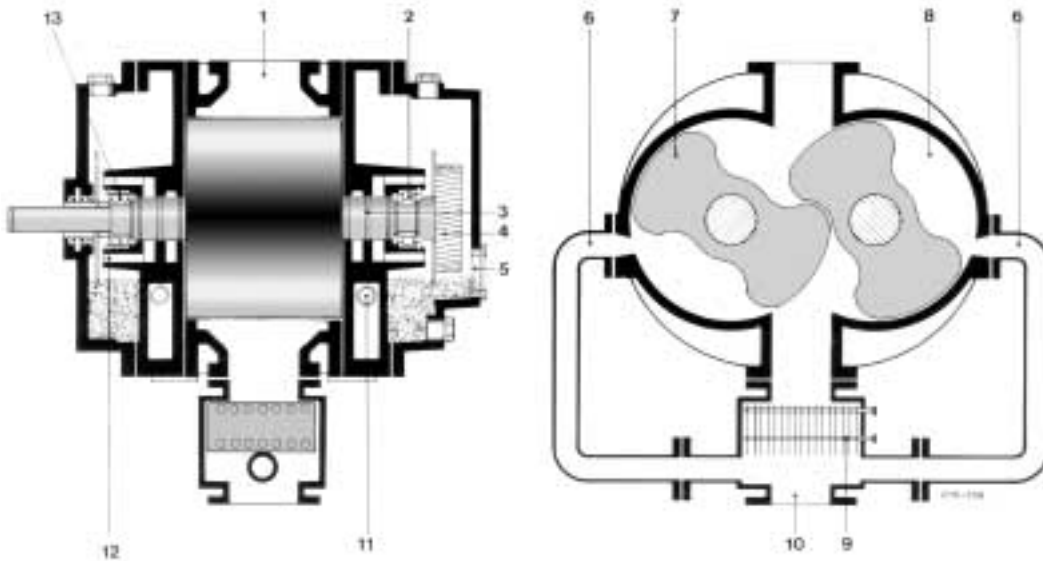

Fig. 7 Sectional representation of a circulatory gas cooled Roots vacuum pump (WGK, Pfeiffer Vacuum GmbH).

- | | | |
|---------------------|-------------------------|------------------------|
| 1 Intake connection | 6 Cooling gas inlet | 11 Temperature control |
| 2 Moveable bearing | 7 Rotor | 12 Oil return line |
| 3 Labyrinth seal | 8 Pumping chamber | 13 Fixed bearing |
| 4 Gears | 9 Gas cooler | |
| 5 Sight glass | 10 Discharge connection | |

2.2 Design and Function of the Circulatory Gas Cooled Roots Vacuum Pumps

The circulatory gas cooled Roots vacuum pump (WGK) has been designed for extreme applications. There are no restrictions where high differential pressures and compression ratios are involved. During the compression and discharge phases, the heat is dispersed by an efficient gas

circulation system. This means that this version can be operated under conditions where the conventional Roots vacuum pump can not be used. Due to their design the rotors are able to control the transport of the process gas and of the cooling gas. The pump cannot overheat, even during final pressure operations with closed intake line.

Roots Vacuum Pumps

Cooling gas connection

Cooling gas connections are located on the sides of the pump. The design of the rotors prevent cooling gas from backstreaming to the intake side. Therefore, the volume flow rate is not affected.

Heat exchanger and motors (for circulatory gas cooled Roots vacuum pumps)

A heat exchanger and motor are required to operate the gas cooled pump. The size and type is determined by the application.

WKP and WGK drives

Motor and pump shafts are connected by an coupling. The motor side shaft feedthrough is fitted with radial shaft seals having a replaceable protective bushing. The space between the sealing rings is filled with sealing oil via an oiler. The sealing oil should be the pump operating medium.

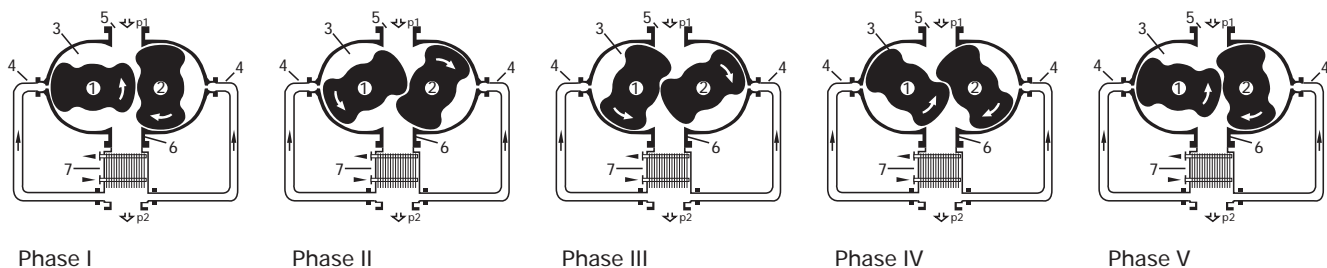

Fig. 8 Principle of the circulatory gas cooled Roots vacuum pumps (WGK, Pfeiffer Vacuum GmbH).

PHASE I

Space 3 is connected to intake port 5 and sucks in gas at a pressure of p_1 when rotors 1 and 2 turn.

PHASE II

Space 3 is sealed off from both intake port 5 and from cold gas inlet 4.

PHASE III

Cold gas streams into space 3 via the cold gas circulation until counter pressure p_2 is attained.

PHASE IV

Space 3 is closed to both cold gas inlet 4 and discharge port 6.

PHASE V

Space 3 is connected to discharge port 6 and the sucked-in gas mixture from intake port 5 and cold gas inlet 4 is expelled. Behind cooler 7 some of the gas, representing the gas volume sucked in at intake port 5, streams into the next pump in series (or is released).

2.3 Special Equipment and Accessories

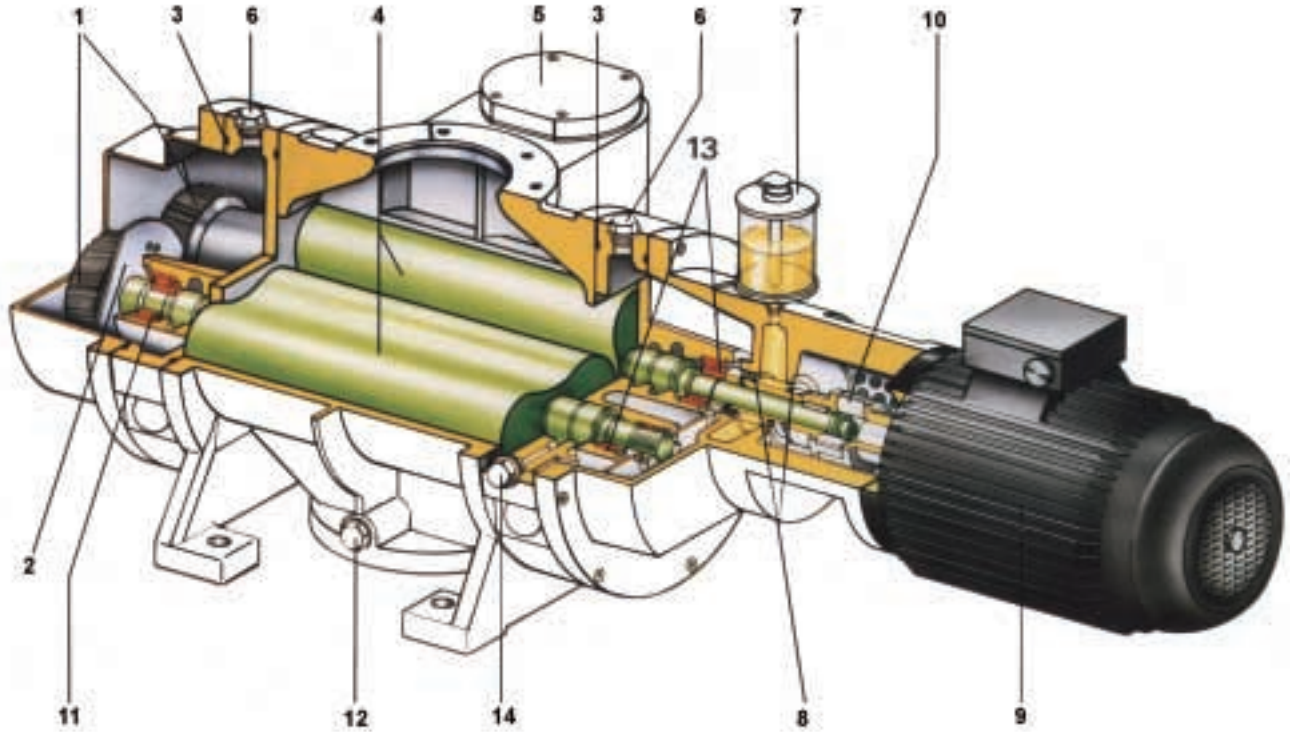

Fig. 9 Section through a Roots Vacuum Pump.
(WKP 500 A, Pfeiffer Vacuum GmbH).

- | | | |
|------------------|--|-------------------------------|
| 1 Gear wheels | 6 Connection for gear chamber evacuation | 10 Coupling |
| 2 Splash disc | 7 Oiler | 11 Roller bearing |
| 3 O-ring seal | 8 Radial shaft seals | 12 Measuring connection |
| 4 Rotors | 9 Motor | 13 Self-aligning ball bearing |
| 5 Overflow valve | | 14 Sealing gas connection |

Measuring connections

The measuring connections on the intake and discharge side of the pump can be utilized to monitor temperature and pressure. The locking screws can be replaced with ISO-KF screw-on small flanges to enable transducers to be connected.

Sealing gas connection

When pumping solvents and reactive gases that life-time of the the lubricant can decrease due to condensation. Reactive gases and vapors can also attack parts of the gear chamber. To prevent this, sealing gas can be introduced into the radial shaft feedthrough area between the working and gear chambers. An inert gas is used as the sealing gas, such as nitrogen (N₂).

Gear chamber evacuation

For rapid evacuation utilizing large Roots Pumping Stations, it is recommended to pre-evacuate, via an oil separator, the gear chamber of a Roots vacuum pump with a separate vacuum pump.

Canned motor

The rotor of the motor operates in vacuum, with the canned motor design. A thin walled, non-magnetic pipe between the rotor and the stator of the motor forms the seal against atmosphere. The advantage of the canned motor is no wear and tear on the radial shaft feedthrough (e.g. radial shaft seals). It is only recommended for clean operations because its protection class is no higher than IP 22 and cannot be designed "explosion proof".

Surface protection

Corrosive gases are present in certain applications. Pump parts which come into contact with such media can be provided with a special surface protection.

The following surface treatments are possible depending on the media:

-Nickel plating-

A nickel layer is applied to all internal parts that come in contact with the gases.

-Phosphatization-

For short term surface protection, e.g. during storage or transport the working chamber of the pump is phosphatized, vented with nitrogen and sealed vacuum tight.

Seals

Roots vacuum pumps are fitted with Viton O-rings as standard. For special applications pumps can be fitted with O-rings and sealing materials tailored to the application.

for example

- VITON/ PTFE-coated
- EPDM
- KALREZ



Roots Vacuum Pump WKP 500 A



PackageLine
Roots Vacuum Pumping Station

Liquid Ring Vacuum Pumps

3 Liquid Ring Vacuum Pumps

In principle, this pump is a combination of an "isotherm" compressing vacuum pump and a contact condenser. Compression generated heat is largely carried away by the operating fluid. Corrosive gases and vapors which condense in liquid ring pumps can be pumped without any problem when utilizing materials such as stainless steel.

ting fluid of the pump can be matched to the medium being pumped. The combination of Roots vacuum pump, gas jet and liquid ring vacuum pump attains a final pressure of approx. 0.2 mbar. If lower pressures are required, an additional Roots vacuum pump will be necessary. The running wheel is seated eccentrically in the housing. When the running wheel turns, the operating fluid in the housing forms a circulating liquid ring which rises up from the hub of the wheel. The pumped gas enters the resulting vacuum through the intake aperture. After almost one whole revolution, the liquid ring approaches the wheel hub and pushes the pumping gas out through the pressure aperture.

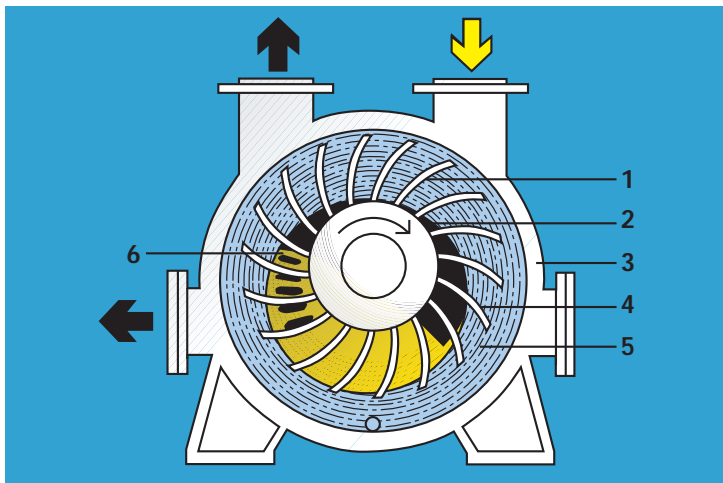

Fig. 10 Section of a single stage liquid ring vacuum pump (Siemens)

- 1 Rotor
- 2 Rotor shaft
- 3 Housing
- 4 Intake channel
- 5 Liquid ring
- 6 Flexible outlet channel

3.1 Design and Function

Compared to rotary vane vacuum pumps, the liquid ring vacuum pump has the disadvantage of a relatively poor final pressure. This is determined by the vapor pressure of the operating fluid which is usually water. At an operational water temperature of 15°C, the liquid ring vacuum pump attains a final pressure of approx. 20 mbar. A liquid ring vacuum pump, operating cavitation free as a result of the introduction of air will attain approx. 25-30 mbar. The great advantage of the liquid ring vacuum pump is the fact that the opera-

3.2 Fresh Fluid Operations

In this type of operation, fresh operating fluid is constantly being supplied to generate the liquid ring. The temperature of the liquid ring and the operating fluid being supplied is the same.

Ideally, operating fluids used in fresh fluid operations should not harm the environment.

3.3 Combined Fluid Operations

In this type of operation, the “new” operating fluid in the liquid ring vacuum pump is continuously being mixed with the operating fluid discharged from the separator. The residual fluid from the separator is disposed of.

$$KB = FB \frac{T_A - T_B}{T_A - T_F}$$

Equation 3

KB (m³/h)

Fresh fluid requirements in combined operations

FB (m³/h)

Operating fluid flow

T_A (°C)

Temperature of the returned “circulating” operating fluid = discharge temperature at pump outlet port

T_B (°C)

Temperature of the operating fluid

T_F (°C)

Temperature of the fresh fluid

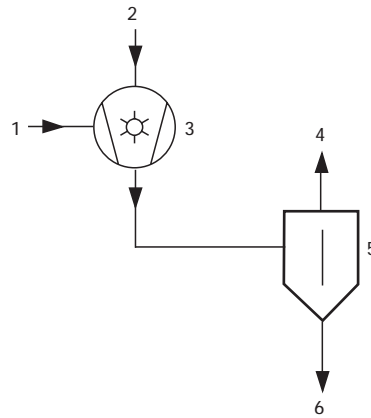

Fig. 11 Fresh fluid operations

- 1 “Fresh” operating fluid
- 2 Gas “ON”
- 3 Liquid ring vacuum pump
- 4 Gas “OFF”
- 5 Separator
- 6 „Used” operating fluid

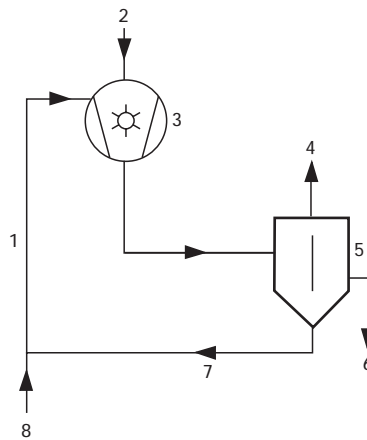

Fig. 12 Combined fluid operations

- 1 Mixed operating fluid
- 2 Gas “ON”
- 3 Liquid ring vacuum pump
- 4 Gas “OFF”
- 5 Separator
- 6 Condensate discharge
- 7 “Used” operating fluid
- 8 “Fresh” operating fluid

3.4 Closed – Circuit Fluid Operations

In this type of operation, used operating fluid, in a closed circuit, is cooled continuously via a heat exchanger. From time to time, operating fluid lost to evaporation must be replaced.

Closed – circuit fluid type of operation is used especially where the pumping of hazardous or environmentally damaging gases is involved.

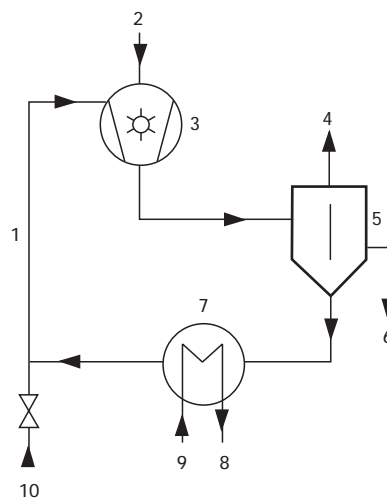

Fig. 13 Closed-circuit fluid operations

- 1 Operating fluid
- 2 Gas “ON”
- 3 Liquid ring vacuum pump
- 4 Gas “OFF”
- 5 Separator
- 6 Condensate discharge
- 7 Heat exchanger
- 8 Cooling Water “OFF”
- 9 Cooling Water “ON”
- 10 Operating fluid supplement

4 Condensers

4.1 Design and Function

In many vacuum processes, e.g. drying and distillation, vapors are generated in such volumes that the water vapor capacity of the rotary vane vacuum pump is exceeded. In these cases, a condenser can provide effective protection for the pump. In addition the volume flow rate of the condenser is very high for vapors so pumping/drying times are considerably reduced. Vapor released during the process condenses on the cooling coils used to conduct the cooling medium. The resulting liquid condensate in the condensate chamber is then routed to the condensate collection reservoir via piping.

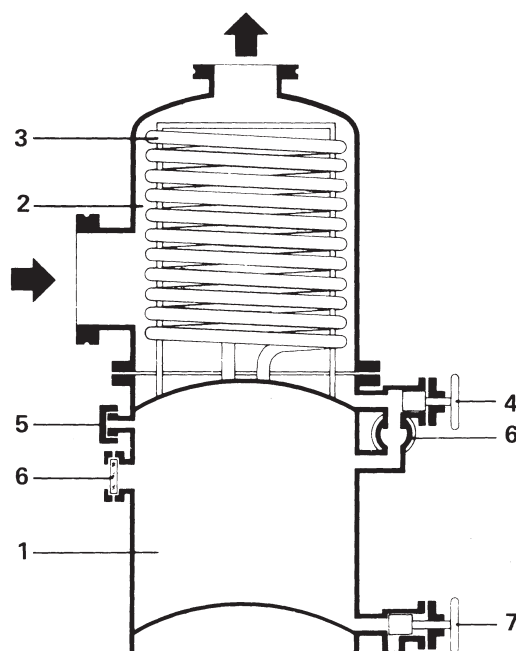

- 1 Collecting vessel
- 2 Condensation chamber
- 3 Cooling coil
- 4 Shut off valve
- 5 Ventilation
- 6 Sight glass
- 7 Outlet valve

Fig. 14 Condensator
(KS, Pfeiffer Vacuum GmbH)

- S (m³/h)
Volume flow rate of a vacuum pumping station
- R $\left(\frac{\text{mbar} \cdot \text{m}^3}{\text{kmol} \cdot \text{K}}\right)$
Universal gas constant $R = 83.14$
- T_{Gas} (K)
Gas inlet temperature
- p (mbar)
Pressure
- \dot{Q} (kg/h)
Material component throughput per hour
- M (kg/kmol)
Molar mass
- A (m²)
Cooling surface
- \dot{Q}_w $\left(\frac{\text{kJ}}{\text{h}}\right)$
Condensation heat/volume per hour
- k $\left(\frac{\text{kJ}}{\text{h} \cdot \text{m}^2 \cdot \text{K}}\right)$
Heat exchange coefficient
- T_m (K)
Mean temperature difference
- $\dot{Q}_{\text{H}_2\text{O}}$ $\left(\frac{\text{kg}}{\text{h}}\right)$
Water vapor volume to be condensed per hour
- $q_{\text{H}_2\text{O}}$ $\left(\frac{\text{kJ}}{\text{kg}}\right)$
Vaporizing heat
- $T_{W \text{ in}}$ (K)
Cooling water inlet temperature
- $T_{W \text{ out}}$ (K)
Cooling water outlet temperature
- ΔT_{high} (K)
Highest temperature difference
- ΔT_{small} (K)
Smallest temperature difference
- T_s (K)
Boiling point at condensation pressure
(in example 1, page 23, $T_s = T_{s \text{ H}_2\text{O}}$)

4.2 Condenser Calculations

Example 1:

a) Calculating the required volume flow rate of a pumping station:

$$S = R \cdot \frac{T_{\text{Gas}}}{p} \cdot \left(\frac{\dot{Q}_1}{M_1} + \frac{\dot{Q}_2}{M_2} + \dots + \frac{\dot{Q}_n}{M_n} \right) [\text{m}^3/\text{h}]$$

Equation 4

$$S = 83.14 \cdot \frac{313}{100} \cdot \left(\frac{100}{18} + \frac{10}{29} \right) [\text{m}^3/\text{h}]$$

$$S = 1535 \text{ m}^3/\text{h}$$

b) Calculating the cooling surface of a condenser:

$$A = \frac{Q_W}{k \cdot T_m} [\text{m}^2]$$

Equation 5

$$Q_W = Q_{\text{H}_2\text{O}} \cdot q_{\text{H}_2\text{O}} \left[\frac{\text{kJ}}{\text{h}} \right]$$

Equation 6

$$T_m = \frac{\Delta T_{\text{high}} + \Delta T_{\text{small}}}{2} [\text{K}]$$

Equation 7

$$\Delta T_{\text{high}} = T_s - T_{W \text{ in}}$$

$$\Delta T_{\text{small}} = T_s - T_{W \text{ out}}$$

$$k \sim 1000 \frac{\text{W}}{\text{m}^2 \text{K}} = 3600 \frac{\text{kJ}}{\text{h} \cdot \text{m}^2 \text{K}}$$

$$\Delta T_{\text{high}} = 318 - 298 = 20 \text{ K}$$

$$\Delta T_{\text{small}} = 318 - 308 = 10 \text{ K}$$

$$T_m = \frac{20 + 10}{2} = 15 \text{ K}$$

$$\dot{Q}_W = 100 \cdot 2257 = 225700 \text{ kJ/h}$$

$$A = \frac{225700}{3600 \cdot 15} \sim 4.5 \text{ m}^2$$

is the required cooling surface of the condenser

Water/vapor volume to be condensed

$$\dot{Q}_{\text{H}_2\text{O}} = 100 \text{ kg/h}$$

Inert gas part (air) in water vapor

$$\dot{Q}_L = 10 \text{ kg/h}$$

Gas inlet temperature

$$T_{\text{GAS}} = 40 \text{ }^\circ\text{C}$$

Cooling water temperature

$$T_{W \text{ in}} = 25 \text{ }^\circ\text{C}$$

Cooling water temperature

$$T_{W \text{ out}} = 35 \text{ }^\circ\text{C}$$

Working pressure

$$p_A = 100 \text{ mbar}$$

Molar mass of water

$$M_1 = 18 \text{ kg/kmol}$$

Molar mass of air

$$M_2 = 29 \text{ kg/kmol}$$

Note!

If T_s is smaller than $T_{W \text{ in}}$ or $T_{W \text{ out}}$ no condensation is possible.

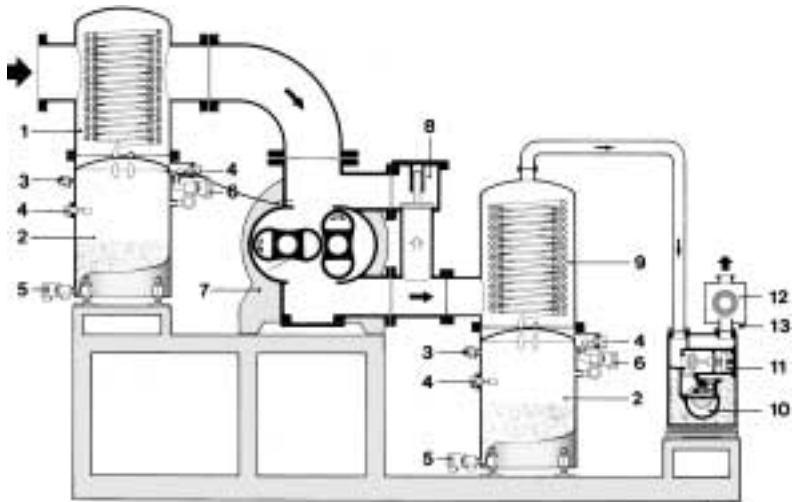

Fig. 15 Layout of a Roots vacuum pumping station (Pfeiffer Vacuum GmbH).

1 Pre-condenser	7 Roots vacuum pump	11 High vacuum safety valve
2 Condensate collecting vessel	8 Overflow valve	12 Oil mist filter
3 Venting valve	9 Intermediate condenser	13 Drain screw
4 Float switch	10 Rotary vane vacuum pump	
5 Drain valve		
6 Shut off valve		

5 Heat Exchangers

5.1 Design and Function

A heat exchanger is a container in which a thin partition separates two media exchanging heat without mixing. One medium flows through the space between tube and tube cladding and the other medium flows through the tube itself. The flow through the cladded space is obstructed by diversion plates setup according to the application in order to maximize the degree of cross flow to the tubes. The flow through the tubes is single or multi type depending on function, velocity and pressure loss.

Heat exchangers can be used in multistage Roots vacuum pumping stations for intermediate cooling and also in gas cooled Roots vacuum pumps. In gas circulatory cooled Roots vacuum pumps the heat exchanger is fitted directly to the gas discharge port, whereby a part of the cooled gas is routed back into the pump as cooling gas. The use of the heat exchangers is based on the compression of the pumped gases (from p_1 to p_2) and the resultant increase in temperature (from T_1 to T_2). With the help of this equipment, pumps and pumping stations are protected against thermal overloading which could otherwise lead to breakdowns.

Types of heat exchangers:

● Tubular:

for all applications

(Guide-line)

3 kW motor power of the pump for 1m² heat exchange surface of the cooler.

● Finned:

only for clean gases

(Guide-line)

1 kW motor power of the pump for 1m² heat exchange surface of the cooler.

Selection of material

The inner tubes of a tubular heat exchanger have the most important function. First, they form the heat exchange surface. Second, the walls of the tubes act to separate the two media.

The selection of material for the inner tubes requires careful consideration because if the wall should break, the two media will mix and the heat exchanger will break down.

A (m²)
Exchange surface

\dot{Q} (kJ/h)
Amount of heat to be exchanged per hour

P (kW)
Calculated required motor power

T_m (K)
Mean temperature difference between gas and cooling medium

$T_{G\ in}$ (K)
Gas inlet temperature

$T_{G\ out}$ (K)
Gas outlet temperature

$T_{W\ in}$ (K)
Cooling water inlet temperature

$T_{W\ out}$ (K)
Cooling water outlet temperature

5.2 Heat Exchanger Calculations

The motor power for a particular working range of a circulatory gas cooled Roots vacuum pump (WGK) has been calculated to be $P = 15 \text{ kW}$.

Because the calculated motor power is the basis for establishing the amount of heat which has to be conducted away from the circulatory gas cooled Roots vacuum pump, such heat must be dispersed by the heat exchanger to prevent overheating.

Example 2

Motor power

$$P = 15 \text{ kW}$$

Gas inlet temperature

$$T_{G \text{ in}} = 120 \text{ °C} = 393 \text{ K}$$

Gas outlet temperature

$$T_{G \text{ out}} = 50 \text{ °C} = 323 \text{ K}$$

(assumed)

Cooling water inlet temperature

$$T_{W \text{ in}} = 30 \text{ °C} = 303 \text{ K}$$

Cooling water outlet temperature

$$T_{W \text{ out}} = 40 \text{ °C} = 313 \text{ K}$$

(assumed)

$k \sim 50$ for finned coolers

$k \sim 180$ for tubular coolers

k -values for the pressure range from atmosphere to approx. 50 mbar.

$$A = \frac{\dot{Q}}{k \cdot \Delta T_m} \text{ [m}^2\text{]}$$

$$\dot{Q} = P \cdot 3600 \text{ [kJ/h]}$$

$$1 \text{ W} = 1 \text{ J/s}$$

$$1 \text{ kW} = 3600 \text{ kJ/h}$$

$$\Delta T_m = \frac{(T_{G \text{ in}} - T_{W \text{ out}}) - (T_{G \text{ out}} - T_{W \text{ in}})}{\ln \left(\frac{T_{G \text{ in}} - T_{W \text{ out}}}{T_{G \text{ out}} - T_{W \text{ in}}} \right)} \text{ [K]}$$

Equation 8

$$\dot{Q} = 15 \cdot 3600 = 54.000 \text{ kJ/h}$$

$$\Delta T_m = \frac{(393 - 313) - (323 - 303)}{\ln \left(\frac{393 - 313}{323 - 303} \right)} \sim 43 \text{ K}$$

for finned coolers where $k \sim 50$:

$$A_L = \frac{54.000}{50 \cdot 43} \sim 25 \text{ m}^2 \text{ exchange surface}$$

for tubular coolers where $k \sim 180$:

$$A_R = \frac{54.000}{180 \cdot 43} \sim 7 \text{ m}^2 \text{ exchange surface}$$

6 Backing Pump Selection

Rotary Vane Vacuum Pumps

The rotary vane vacuum pump represents the ideal backing pump for Roots vacuum pumping stations. It has constant pumping speed over a wide pressure range. The single stage rotary vane vacuum pump can compress from approximately 0.5 mbar to 1000 mbar even with an open gas ballast valve. This means that with this backing pump, a Roots vacuum pumping station can attain a final pressure of 10^{-2} mbar and lower with open gas ballast valve.

Water vapor, various solvents and other vapors e.g. alcohols, paraffin and many others can be pumped by the rotary vane vacuum pump providing they have a sufficiently high vapor pressure and do not chemically decompose the pump oil.

Liquid ring vacuum pumps

Situations arise where substances have to be pumped which attack and decompose the backing pump oil or which have such a low vapor pressure that condensation in the pump is unavoidable. In such cases, the liquid ring vacuum pump represents a viable alternative as a backing pump.

Compared to rotary vane vacuum pumps, the liquid ring vacuum pump has the disadvantage of a relatively poor final pressure. At an operational temperature of 15°C, the liquid ring vacuum pump attains a final pressure of approx. 20 mbar.

A liquid ring vacuum pump, operating cavitation free as result of the introduction of air will attain 25-30 mbar at best. A combination of Roots vacuum pump and liquid ring vacuum pump will attain a final pressure of approx. 1 mbar.

Liquid ring vacuum pumps with gas jet

The combination of Roots vacuum pump, gas jet and liquid ring vacuum pump attains a final pressure of approx. 0.2 mbar. If lower pressures are required, an additional Roots vacuum pump will be necessary.

When pumping environmentally hazardous substances, liquid ring vacuum pumps must not be operated with fresh water. A closed circuit must be provided in which an appropriate operating fluid is used to remove the heat of compression via a heat exchanger.

Circulatory gas cooled Roots vacuum pumps

The circulatory gas cooled version of the Roots vacuum pump is another type of backing pump used for situations where high pressure differentials are involved. Because the Roots is a completely dry operating vacuum pump, it can be recommended for those situations where liquid compressing working chamber pumps are excluded. Specific applications include:

- Pumping off and compressing helium on cryostats
- Pumping off and compressing SF₆
- Clean reclamation of diverse gases in technological processes, e.g. distillation, pumping off of molecular sieves etc.
- Pumping toxic substances in closed systems
- Pumping down very large vessels

Roots vacuum pumping stations with circulatory gas cooled Roots vacuum pumps present very different pumping characteristics. In extreme cases, an almost constant volume flow rate is attainable over the whole pressure range from 1 bar to 10^{-3} mbar. Naturally, the Roots vacuum pumps must be provided with correct motors and with outlet valves to atmosphere instead of overflow valves.

Figure 16 shows the number of stages required for a particular working pressure. The values are valid for air and most gases and vapors. Additional stages are necessary if the pumping of helium and hydrogen is involved.

Such a pumping station configuration primarily evacuates large volumes. Figure 17 shows the volume flow rate of such a pumping station.

Stage	V	IV	III	II	I
Final pressure	$< 10^{-3}$ mbar	$2 \cdot 10^{-2}$ mbar	1 mbar	20-30 mbar	100-200 mbar
Working-pressure	$5 \cdot 10^{-3}$ mbar	$5 \cdot 10^{-2}$ mbar	2 mbar	30-50 mbar	300 mbar
					1000 mbar

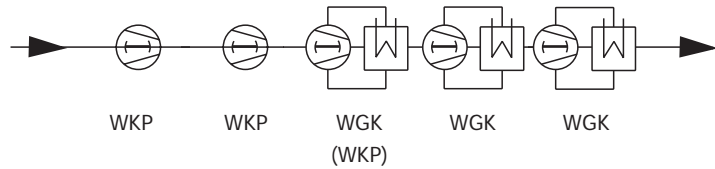

Fig. 16 Relationship between attainable final pressure/working pressure and number of stages when evacuating with Roots vacuum pumps (for air).

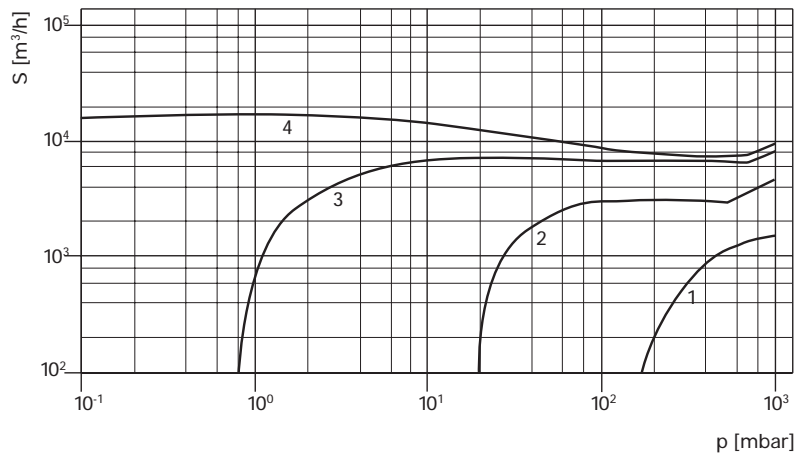

Fig. 17 Volume flow rate curve of a four stage Roots vacuum pumping station

- 1 WGK 1500
- 2 WGK 4000 – WGK 1500
- 3 WGK 8000 – WGK 4000 – WGK 1500
- 4 WGK 18000 – WGK 8000 – WGK 4000 – WGK 1500

Backing Pump Selection

Maximum compression ratio

Pumped off gases and vapors stream back through the gap between rotors and pump housing in the direction of the intake side. This backstreaming reduces the effective volume flow rate of the Roots vacuum pump and becomes more difficult the higher the back pressure and the greater the difference between intake and back pressure. The maximum compression ratio K_m is attained if all the pumped gas has backstreamed so that the volume flow rate is zero. The K_m value reflects the level of efficiency of the Roots vacuum pump and is required for the effective volume flow rate calculation. In practice, the K_m value is measured at the blank flanged intake port for the required back pressure. Fig. 18 shows the compression ratio dependent on the backing pressure of the WKP series.

The diagram shows that when compressing against atmosphere, the Roots vacuum pump has a low compression rate. It then increases steadily until at a back pressure of approx. 2 mbar the maximum value of 50 to 70 is reached. The drop which then follows is based on the clearance between rotors and housing owing to the effect of backstreaming in the molecular flow range. There are limits of compression with Roots vacuum pumps in certain pressure ranges. Because of this a backing pump is required.

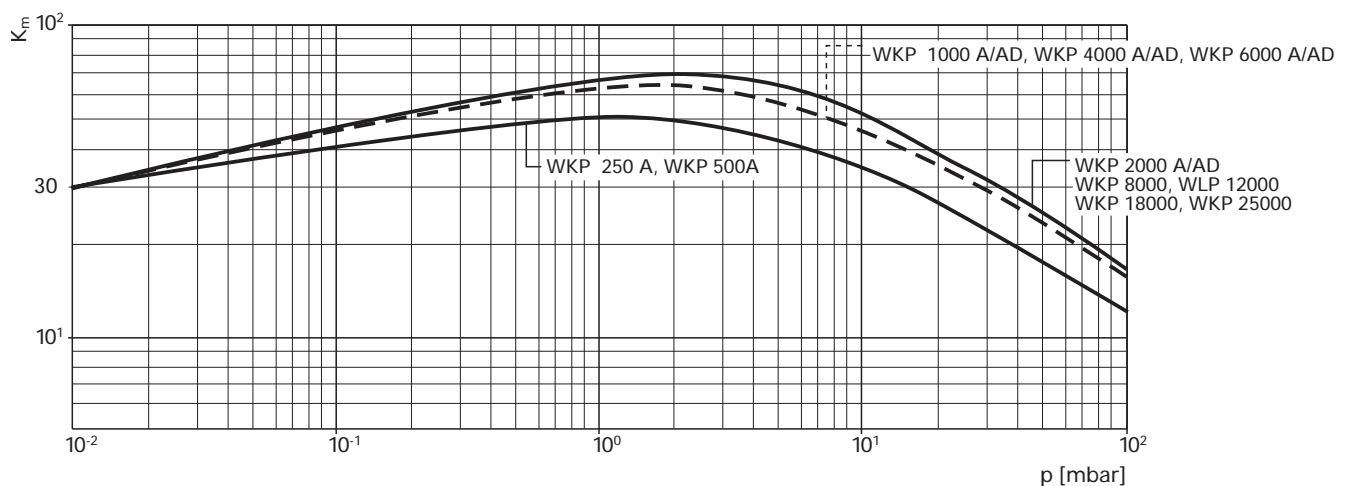

Fig. 18 Maximum compression ratio K_m ¹⁾ for Roots vacuum pumps (WKP) when pumping air²⁾.

¹⁾ This K_m -value is valid for pumps which operate at nominal rotational speed.

²⁾ For helium, the value should be multiplied by a factor of 0.66.

7 Calculations

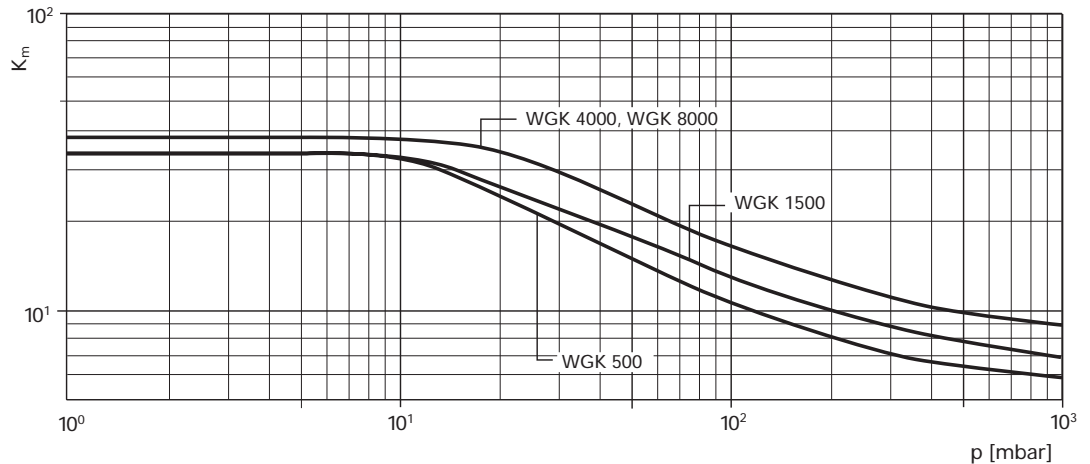

Fig. 19 Maximum compression ratio K_m ¹⁾ for circulatory gas cooled Roots vacuum pumps (WKP) when pumping air²⁾.

- ¹⁾ This K_m -value is valid for pumps which operate with low nominal rotational speed.
- ²⁾ For helium, the value should be multiplied by a factor of 0.66.

7.1 Power Consumption of a Roots Vacuum Pump

The Roots vacuum pump is a pure positive displacement pump without internal pre-compression. For this reason, the pressure differential between intake and discharge sides and the theoretic working volume are all proportional.

The mechanical loss is small and depending on the type of drive ranges between 5% and 15%. The use of relays for hard starting are recommended in the switch box. The power requirements after running up in the medium vacuum range are low.

$$P = \frac{S_{th} \cdot \Delta p}{36000 \cdot \eta_{mech}} \text{ [kW]}$$

Equation 9

S_{th} (m³/h)
Theoretical volume flow rate of Roots vacuum pumps

Δp (mbar)
Pressure differential between intake and discharge ports

η_{mech}
Mechanical efficiency rate of the pump
($\eta \sim 0.85$ for Roots vacuum pumps)

P (kW)
Power requirements/motor power

Example 3

A WKP 8000 Roots vacuum pump should compress gas from 0.5 mbar to 5 mbar. ($S_{th} = 8000 \text{ m}^3/\text{h}$).

The drive power P is required in kW.

Theoretic Roots vacuum pump volume flow rate $S_{th} = 8000 \text{ m}^3/\text{h}$

Pressure differential between intake and pressure ports $\Delta p = 4.5 \text{ mbar}$

Pump efficiency rate $\eta_{mech} = 0.85$

Solution:

$$P = \frac{8000 \cdot 4.5}{36000 \cdot 0.85} = 1.18 \text{ kW drive power}$$

7.2 Volume Flow Rate of a Roots Vacuum Pumping Station

The volume flow rate of a Roots vacuum pump is dependent on back pressure in the whole suction range and is therefore influenced by the volume flow rate of the backing pump.

When a Roots vacuum pump is combined with various backing pumps, different volume flow rate curves are obtained over the whole pressure range for the same Roots vacuum pump. This means that the effective volume flow rate of a Roots vacuum pump can only be stated in relation to a specific backing pump. For this reason the identification size of a Roots vacuum pump is stated in terms of the theoretical volume flow rate (also known as the nominal volume flow rate).

With respect to a defined backing pump, on approximation of the volume flow is calculated as follows:

$$S = S_{th} \cdot \frac{K_m}{K_m + \frac{S_{th}}{S_v} - \left(\frac{S_v}{S_{th}}\right)^{1.5}} \text{ [m}^3\text{/h]} \quad \text{Equation 10}$$

and the assigned intake pressure to:

$$p = \frac{S_v \cdot p_v}{S} \text{ [mbar]} \quad \text{Equation 11}$$

S (m³/h)
Volume flow rate of the Roots vacuum pump at the intake port

S_{th} (m³/h)
Theoretical volume flow rate of the Roots vacuum pump

S_v (m³/h)
Volume flow rate of the backing pump at a pressure of p_v

p_v (mbar)
Fore-vacuum (back pressure)

p (mbar)
Intake pressure of the Roots vacuum pump

Δp (mbar)
Set pressure differential at the overflow valve of the Roots vacuum pump

K_m
Maximum compression ratio of the Roots vacuum pump at p_v

a
Correction factor a (see page 54 Figure 26)

η_{vol}
Volumetric efficiency rating

If it is required to compress from a specific intake pressure against a constant back pressure (e.g. condensation pressure in a condenser), an approximation of the volume flow is calculated as follows:

$$S = S_{th} \cdot \left(1 - \frac{p_v}{p} \cdot \frac{a}{K_m}\right) \text{ [m}^3\text{/h]} \quad \text{Equation 12}$$

Equation 12

$$\frac{p_v}{p} \geq 2.5 \rightarrow a = 1$$

$$\frac{p_v}{p} \leq 2.5 \rightarrow a = \frac{p_v^3 - p^3}{0.963 \cdot p_v^3} \text{ [mbar]} \quad \text{Equation 13}$$

Equation 13

The volume flow rate can only be calculated according to equations 10 or 12 providing the overflow valve of the Roots vacuum pump is closed. That is, $p_v - p$ is smaller than the pressure differential set at the

overflow valve. In the response range of the overflow valve, the volume flow rate can be calculated according to:

$$S = \frac{S_v \cdot (p + \Delta p)}{p} \text{ [m}^3\text{/h]}$$

Equation 14

In this equation, Δp denotes the set pressure differential at the Roots vacuum pump overflow valve. In case of doubt, the calculation must be worked via the K_m value (equation 10 or 12) and the overflow valve (equation 14) where the lower of the values produced is the right one.

Example 4

A Roots vacuum pump WKP 4000 ($S_{th} = 4000 \text{ m}^3\text{/h}$) should compress from 5 mbar to 20 mbar. Required is the volume flow rate.

K_m -value according to Fig. 18 for $p_v = 20 \text{ mbar} \rightarrow K_m = 34$

$$S = S_{th} \cdot \left(1 - \frac{p_v \cdot a}{p \cdot K_m}\right) \text{ [m}^3\text{/h]}$$

For $\frac{p_v}{p} = 4$ derived from equation 12

$$\rightarrow a = 1$$

$$S = 4000 \cdot \left(1 - \frac{20 \cdot 1}{5 \cdot 34}\right) = 3529 \text{ m}^3\text{/h}$$

at 5 mbar.

7.2.1 Calculating the Volume Flow Rate of a WOD 220 A Pumping Station

The WOD 220 A comprises a single stage rotary vane vacuum pump UNO 30 A and a Roots vacuum pump WKP 250 A.

Example 5

(please also refer to Figure 20)

Calculation of the pressure range of a closed overflow valve on the Roots vacuum pump (as per equations 10 and 11).

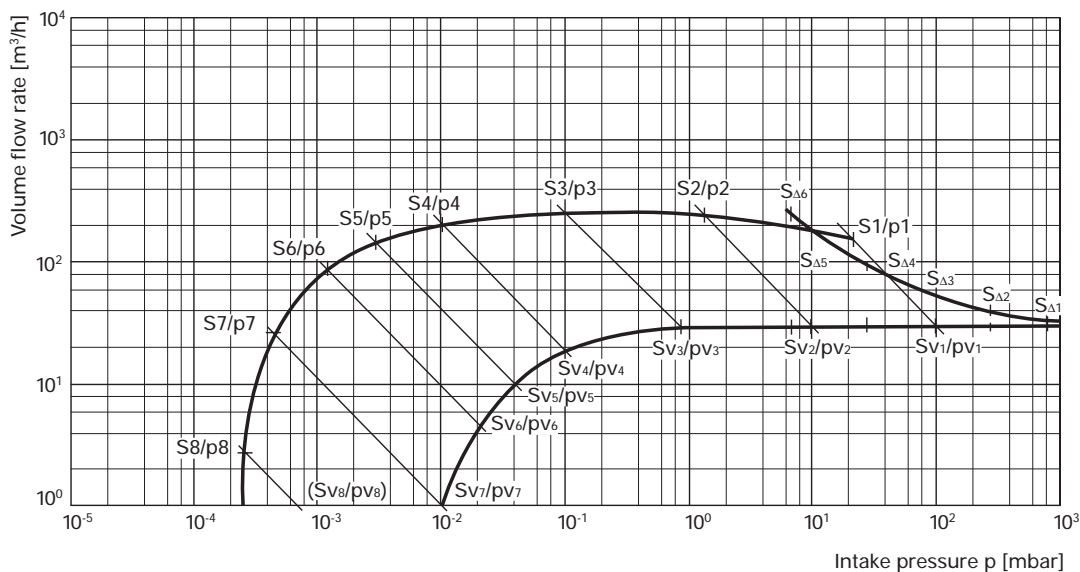

Fig. 20: Volume flow rate curve for example 5

Calculations

$$S_{V1} = 34 \text{ m}^3/\text{h}$$

$$p_{V1} = 100 \text{ mbar}$$

(volume flow rate S_{V1} at a backing pump pressure of P_{V1})

$$S_1 = 270 \frac{12}{12 + \frac{270}{34} - \left(\frac{34}{270}\right)^{1.5}} = 163 \text{ m}^3/\text{h}$$

$$p_1 = \frac{34 \cdot 100}{163} = 21 \text{ mbar}$$

$$S_{V2} = 34 \text{ m}^3/\text{h}$$

$$p_{V2} = 10 \text{ mbar}$$

$$S_2 = 270 \frac{33}{33 + \frac{270}{34} - \left(\frac{34}{270}\right)^{1.5}} = 218 \text{ m}^3/\text{h}$$

$$p_2 = \frac{34 \cdot 10}{218} = 1.5 \text{ mbar}$$

$$S_{V3} = 30 \text{ m}^3/\text{h}$$

$$p_{V3} = 0.75 \text{ mbar}$$

$$S_3 = 270 \frac{47}{47 + \frac{270}{30} - \left(\frac{30}{270}\right)^{1.5}} = 277 \text{ m}^3/\text{h}$$

$$p_3 = \frac{30 \cdot 0.75}{277} = 0.1 \text{ mbar}$$

$$= 1.0 \times 10^{-1} \text{ mbar}$$

$$S_{V4} = 20 \text{ m}^3/\text{h}$$

$$p_{V4} = 0.1 \text{ mbar}$$

$$S_4 = 270 \frac{38}{38 + \frac{270}{20} - \left(\frac{20}{270}\right)^{1.5}} = 199 \text{ m}^3/\text{h}$$

$$p_4 = \frac{20 \cdot 0.1}{199} = 0.01 \text{ mbar}$$

$$= 1.0 \cdot 10^{-2} \text{ mbar}$$

$$S_{V5} = 12 \text{ m}^3/\text{h}$$

$$p_{V5} = 0.04 \text{ mbar}$$

$$S_5 = 270 \frac{30}{30 + \frac{270}{12} - \left(\frac{12}{270}\right)^{1.5}} = 154 \text{ m}^3/\text{h}$$

$$p_5 = \frac{12 \cdot 0.04}{154} = 0.0031 \text{ mbar}$$

$$= 3.1 \cdot 10^{-3} \text{ mbar}$$

$$S_{V6} = 5 \text{ m}^3/\text{h}$$

$$p_{V6} = 0.02 \text{ mbar}$$

$$S_6 = 270 \frac{30}{30 + \frac{270}{5} - \left(\frac{12}{270}\right)^{1.5}} = 96 \text{ m}^3/\text{h}$$

$$p_6 = \frac{5 \cdot 0.02}{96} = 0.001 \text{ mbar}$$

$$= 1 \cdot 10^{-3} \text{ mbar}$$

$$S_{V7} = 1.0 \text{ m}^3/\text{h}$$

$$p_{V7} = 0.012 \text{ mbar}$$

$$S_7 = 270 \frac{30}{30 + \frac{270}{1.0} - \left(\frac{1.0}{270}\right)^{1.5}} = 27 \text{ m}^3/\text{h}$$

$$p_7 = \frac{1.0 \cdot 0.012}{27} = 0.00044 \text{ mbar}$$

$$= 4.4 \cdot 10^{-4} \text{ mbar}$$

$$S_{V8} = 0.1 \text{ m}^3/\text{h}$$

$$p_{V8} = 0.01 \text{ mbar}$$

$$S_8 = 270 \frac{30}{30 + \frac{270}{0.1} - \left(\frac{0.1}{270}\right)^{1.5}} = 3 \text{ m}^3/\text{h}$$

$$p_8 = \frac{0.1 \cdot 0.01}{3} = 0.00033 \text{ mbar}$$

$$= 3.3 \cdot 10^{-4} \text{ mbar}$$

Calculation for the (pressure) range of an open overflow valve on the Roots vacuum pump (as per equation 14).

$$S_{\Delta 1} = \frac{34 (1000 + 53)}{1000} = 36 \text{ m}^3/\text{h}$$

at 1000 mbar

$$S_{\Delta 2} = \frac{34 (300 + 53)}{300} = 40 \text{ m}^3/\text{h}$$

at 300 mbar

$$S_{\Delta 3} = \frac{34 (100 + 53)}{100} = 52 \text{ m}^3/\text{h}$$

at 100 mbar

$$S_{\Delta 4} = \frac{34 (30 + 53)}{30} = 94 \text{ m}^3/\text{h}$$

at 30 mbar

$$S_{\Delta 5} = \frac{34 (20 + 53)}{20} = 124 \text{ m}^3/\text{h}$$

at 20 mbar

$$S_{\Delta 6} = \frac{34 (7 + 53)}{7} = 291 \text{ m}^3/\text{h}$$

at 7 mbar

7.3 Volumetric Efficiency Rating

The volumetric efficiency rating η_{vol} is often used when calculating the volume flow rate:

$$\eta_{vol} = \frac{S}{S_{th}}$$

Equation 15

$$\eta_{vol} = \frac{K_m}{K_m + \frac{S_{th}}{S_v} - \left(\frac{S_v}{S_{th}}\right)^{1.5}}$$

Equation 16

$$\eta_{vol} = 1 - \frac{p_v \cdot a}{p \cdot K_m}$$

The volume flow rate of a Roots vacuum pump is directly influenced by the volume flow rate of the backing pump. A whole range of options is available.

When performing Roots vacuum pump calculations it has to be remembered that the volumetric efficiency rating falls rapidly with increasing intake pressure. If a volumetric efficiency rating of 0.85 is attained at a theoretical graduation of 10:1 to 10^{-1} mbar, at 4 mbar the rating has reduced to 0.7. This means that the pump is no longer effective in non-stop operations whereas in critical cases, at 10^{-1} a theoretical graduation of 20:1 is still viable. Between 10 and 100 mbar a graduation between 5:1 and 2:1 is possible.

7.4 Conductance Calculations

The volume flow rate of a vacuum pumping station is reduced by piping and components such as valves and bellows fitted upstream of the recipient. The longer the piping and the smaller the diameter the greater the losses.

The conductance value L is used to determine the extent of line losses. The value is dependent not only on the length and diameter of the piping, but also on the type of flow and the nature of the substance²⁾ being pumped. In vacuum technology, it is laminar and molecular flow which are mainly involved. In the laminar flow range the conductance value is pressure dependent; in the molecular flow range, conductance value is pressure independent.

Conductance for round pipes is calculated universally for all pressure ranges in vacuum technology and for all types of gas:

L (m³/h)
Conductance value

S (m³/h)
Volume flow rate at the beginning of the pipe (pump)

S_{eff} (m³/h)
Volume flow rate at the end of pipe (recipient)

p (mbar)
Pressure at the beginning of the pipe

p_{eff} (mbar)
Pressure at the end of the pipe

p_m (mbar)
Mean pressure = $\frac{p + p_{eff}}{2}$

r (cm)
Pipe radius

l (cm)
Pipe length

T (K)
Gas temperature

M $\frac{kg}{k \text{ mol}}$
Gas molar mass

η (Pa · s)
Gas viscosity

²⁾ Please note: data on substances can be found in Appendix Section 8.5, page 52

$$L = \frac{3.6 \cdot r^3}{l} \cdot \left(0.039 \frac{r \cdot p_m}{\eta} + 30 \sqrt{\frac{T}{M}} \right) \quad [\text{m}^3/\text{h}]$$

Equation 17

or for air at 20 °C:

$$L = \frac{3.6 \cdot r^3}{l} (2150 \cdot r \cdot p_m + 95) \quad [\text{m}^3/\text{h}]$$

Equation 18

Laminar flow range

In the laminar flow range (Figure 21) the second term in parentheses can be omitted, yielding a simplified formula for air:

$$L = 7750 \frac{r^4 \cdot p_m}{l} \quad [\text{m}^3/\text{h}]$$

Equation 19

Air, laminary, at 20°C

Molecular flow range

In the molecular flow (Figure 21) the second term in parentheses can be omitted, yielding a simplified formula for air:

$$L = 340 \frac{r^3}{l} \quad [\text{m}^3/\text{h}]$$

Equation 20

Air, molecular, at 20°C

For sequential arrangement of individual conductance values, the following is valid:

$$L = \frac{1}{\frac{1}{L_1} + \frac{1}{L_2} + \frac{1}{L_3}} \quad [\text{m}^3/\text{h}]$$

Equation 21

For parallel arrangement of individual conductance values, the following is valid:

$$L = L_1 + L_2 + L_3 \dots [\text{m}^3/\text{h}]$$

Equation 22

Effective volume flow rate

Effective pressure

The effective volume flow rate S_{eff} at the end of the pipe is calculated from the conductance value L and the volume flow rate at the beginning of the pipe as

$$S_{\text{eff}} = \frac{1}{\frac{1}{L} + \frac{1}{S}} = \frac{L \cdot S}{L + S} \quad [\text{m}^3/\text{h}]$$

Equation 23

and

$$p_{\text{eff}} = \frac{S \cdot p}{S_{\text{eff}}} \quad [\text{mbar}]$$

Equation 24

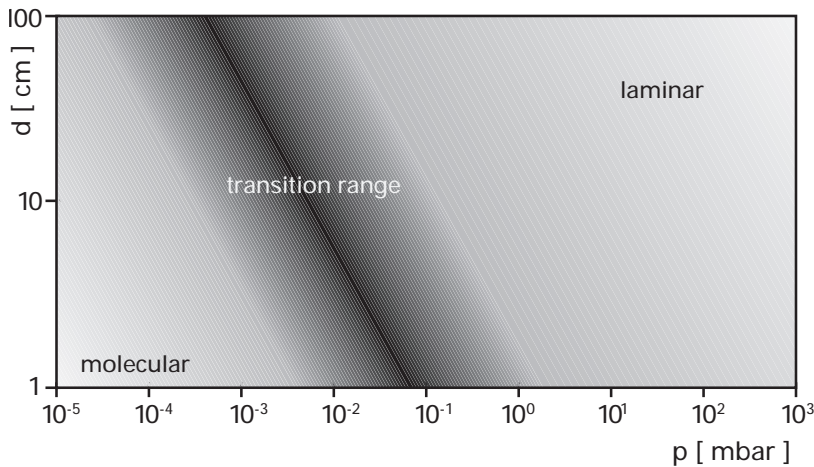

Fig. 21
Representation
of pressure/pipe
diameter
dependent flow
range

Example 6

A pumping station connected to a non stop operating drier will attain a pressure of 0.15 mbar due to the gas volume at the pumping port. The volume flow rate is 3500m³/h. The piping has a diameter of 200 mm and is 10 m long with three 90° bends and includes an angle valve.

The effective volume flow rate and the pressure at the drier are required.

The equivalent pipe length as per table 3:
For one pipe bend DN 200 \triangleq 0.6 m and
for an angle valve DN 200 \triangleq 0.85 m.

Total length to be used =
 $10 + 3 \cdot 0.6 + 0.85 = 12.65$ m

Because the mean pressure is derived from the result, it must first be estimated and a value of 0.17 is taken.

Total conductance value:

$$L = \frac{3.6 \cdot 10^3}{1265} \cdot (2150 \cdot 10 \cdot 0.17 + 95)$$

$$L = 10670 \text{ m}^3/\text{h}$$

$$S_{\text{eff}} = \frac{3500 \cdot 10670}{3500 + 10670} = 2635 \text{ m}^3/\text{h}$$

$$p_{\text{eff}} = \frac{3500 \cdot 0.15}{2635} = 0.199 \sim 0.2 \text{ mbar}$$

$$p_m = \frac{0.2 + 0.15}{2} = 0.175 \text{ mbar}$$

The actual mean pressure is 0.175 which hardly affects the final result, as can be seen.

$$L = \frac{3.6 \cdot 10^3}{1265} \cdot (2150 \cdot 10 \cdot 0.175 + 95)$$

$$L = 10978 \text{ m}^3/\text{h}$$

$$S_{\text{eff}} = \frac{3500 \cdot 10978}{3500 + 10978} = 2655 \text{ m}^3/\text{h}$$

$$p_{\text{eff}} = \frac{3500 \cdot 0.15}{2655} = 0.198 \sim 0.2 \text{ mbar}$$

Nominal width (mm)	10	25	40	63	100	160	200	250	350	500	1000
Y valve	0.12	0.25	0.35	0.35	0.6	1.10	1.35	-	-	-	-
Angle valve	0.1	0.2	0.25	0.3	0.35	0.60	0.85	1.0	1.2	1.6	2.9
Elbow 90°, D = 3d	0.03	0.07	0.12	0.2	0.3	0.5	0.6	0.75	1.0	1.4	2.8

Table 3
Equivalent pipe
lengths in m for
various vacuum
components

Example 7

At the end of a pipe with the same configurations as in the previous example, an effective volume flow rate of 2900 m³/h should be attained at 0.2 mbar for air.

For what volume flow rate S and what intake pressure p should the pumping station be configured?

The length of the pipe has already been established as 12.65 m. Because the anticipated intake pressure is slightly under 0.15 mbar, the mean intake pressure is estimated as 0.17 mbar. This again yields a conductance value of:

$$L = 10670 \text{ m}^3/\text{h}$$

By transposing

$$S_{\text{eff}} = \frac{S \cdot L}{S + L} \rightarrow S = \frac{L \cdot S_{\text{eff}}}{L - S_{\text{eff}}}$$

$$S = \frac{10670 \cdot 2900}{10670 - 2900} = 3982 \text{ m}^3/\text{h}$$

and from

$$p_{\text{eff}} = \frac{S \cdot p}{S_{\text{eff}}}$$

$$p = \frac{S_{\text{eff}} \cdot p_{\text{eff}}}{S}$$

$$p = \frac{2900 \cdot 0.2}{3982} = 0.146 \text{ mbar}$$

$$p_m = \frac{0.2 + 0.146}{2} = 0.173 \text{ mbar}$$

Owing to the minimal deviation from the applied value (0.17 mbar), a correction calculation is unnecessary.

7.5 Pump Down Times

The pump down time is determined primarily by the pumping station volume flow rate and the recipient. Pump down time is also influenced by other factors such as the tightness of the complete

vacuum system, the dimensions of the exhaust lines, any vaporization of fluids, degassing of materials such as porous and large surface objects and contaminated walls.

If the volume flow rate S for the pressure range p₁ to be calculated is constant, the pump down time can be expressed as:

$$t = \frac{V}{S} \ln \frac{p_1}{p_2} \text{ [h]}$$

Equation 25

Example 8

A recipient of 12 m³ should be evacuated from 1000 mbar (atmospheric pressure) to 15 mbar in 0.3 h. What is the required volume flow rate?

By transforming equation 25, the following is obtained:

$$S = \frac{V}{t} \ln \frac{p_1}{p_2}$$

$$S = \frac{12}{0.3} \ln \frac{1000}{15} = 168 \text{ m}^3/\text{h}$$

V (m³)
Volume of the recipient

S (m³/h)
Volume flow rate of the pumping station at the intake port

S_v (m³/h)
Volume flow rate of the backing pump

p_{1,2} (mbar)
Pressure (pressure range from p₁ and p₂)

Δp (mbar)
Set pressure differential at the overflow valve of the Roots vacuum pump

t (h)
Pump down time

This calculation shows that a volume flow rate of 168 m³/h at the recipient must be constant throughout the range 1000 mbar to 15 mbar. More often than not, pumping stations have volume flow rates that differ over the pressure range. In these cases there are a number of ways in which the pump down time can be determined.

Procedure

The method most commonly used in individual cases involves dividing the volume flow rate curve over the pressure in several partial ranges of pressure in which there is little variation in volume flow rate. For these individual pressure ranges, the partial pump down times with their respective mean volume flow rate must be calculated individually according to equation 25 and added to arrive at the total pump down time. An example of this is given in Figure 22, partial range 2 – 5.

Sometimes the volume flow rate for a particular pressure range can be expressed by an equation. This is, for example, the case with a Roots vacuum pump with open overflow valve. Depending on the staging to the backing pump, the range approx. 1000 to 10/20 mbar. An approximation to the volume flow rate here is:

$$t = \frac{V}{S} \ln \frac{p_1 + \Delta p}{p_2 + \Delta p} = [h]$$

Equation 26

Example 9

Figure 22 shows the combined pump down time calculation of a tight, clean 200m³ chamber from 1000 mbar to 10⁻² mbar according to a given volume flow rate curve.

For the pressure range 1000 to 10 mbar (in Figure 22, Section 1) the partial pump down time t_1 is calculated as per equation 26. For the pressure range 10 to 10⁻² mbar equation 25 is applied in as much the volume flow rate is divided in the pressure range 2 to 5 and the individual pump down times t_2 to t_5 calculated.

The total pump down time of $t_{ges} \sim 3.3$ hours under ideal conditions is arrived at by adding all partial pump down times t_1 to t_5 .

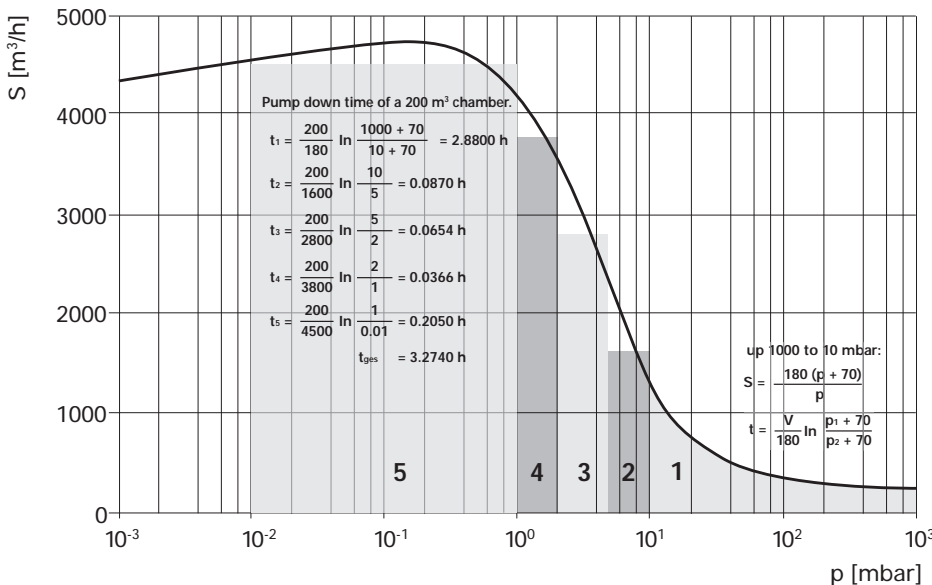

Fig. 22
Calculation of
pump down times
in stages

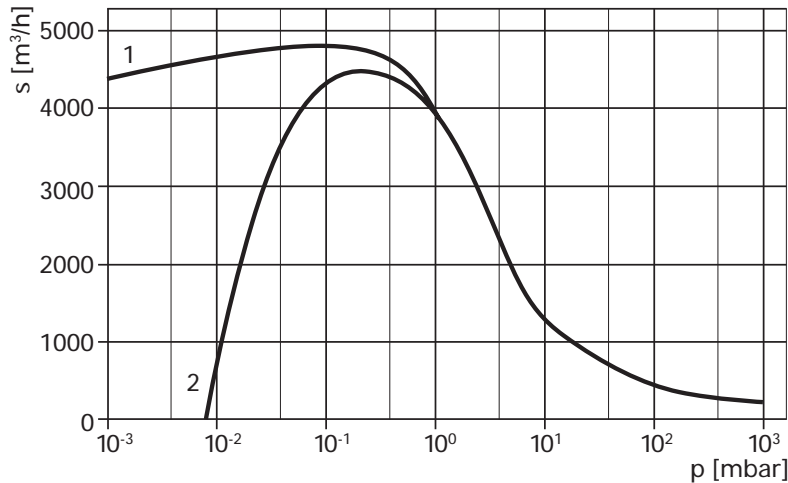

Fig. 23
The influence of the leak rate on the volume flow rate of a Roots vacuum pump.

1 Volume flow rate without taking the leak rate into account (as per example 9).

2 Volume flow rate taking the leak rate into account (as per Example 10).

7.6 The Influence of Leaks on Pump Down Times and End Vacuum (Leak Rate)

Lack of tightness (leaks) in the whole system must be taken into account when the configuration of a vacuum pumping station is under consideration. The leak rate, which is expressed in mbar l/s, is calculated on the basis of known leak locations in feedthroughs and seals, etc. or by means of the pressure rise method. Taking the leak rate into account, the required volume flow rate at a specific pressure.

$$S_{\text{erf}} = \frac{3.6 \cdot q_L}{p} = [\text{m}^3/\text{h}]$$

Equation 27

S_{erf} (m³/h)

Required volume flow rate of the pumping station at the recipient

p (mbar)

Working pressure

$$q_L = \left(\frac{\text{mbar l}}{\text{s}} \right)$$

Total leak rate (of the system)

Example 10

given: leak rate $q_L = 11.68$ mbar l/s

Required: volume flow rate at 1 mbar, 10^{-1} and 10^{-2} mbar

$$S_{\text{erf}} = \frac{3.6 \cdot q_L}{p} = \frac{3.6 \cdot 11.68}{1} = 42 \text{ m}^3/\text{h}$$

at $1 \cdot 10^{-1}$ mbar:

$$S_{\text{erf}} = 420 \text{ m}^3/\text{h}$$

at $1 \cdot 10^{-2}$ mbar:

$$S_{\text{erf}} = 4200 \text{ m}^3/\text{h}$$

If the volume flow rate curve resulting from example 9 is compared with the curve which takes the leak rate into account (see Fig. 23), one can see that:

- at 1 mbar the leak rate is negligible
- at 10^{-1} the volume flow rate is reduced by approx. 10%
- at 10^{-2} the volume flow rate is reduced by approx. 96%.

If the pump down time is now recalculated using this leak rate, there is an increase in pump down time of approx. 50% from 0.205 h to 0.31 h between 1 and 10^{-2} mbar. The attainable final pressure of the pumping station according to example 9 (Figure 22) is limited to 9.4×10^{-3} mbar due to this leak rate.

7.7 Drying Process

In a drying process, 40 kg of water, which evaporates at 20°C, has to be pumped off. In addition, 50 kg of air enters through a leak in the recipient.

V (m³)
(Gas-) volume

T (K)
Temperature

p (mbar)
(Working) pressure

$M = \left(\frac{\text{kg}}{\text{kmol}} \right)$
Molar mass of each component

\dot{Q} (kg)
Throughput of each component

$R = \left(\frac{\text{mbar} \cdot \text{m}^3}{\text{kmol} \cdot \text{K}} \right)$
Universal gas constant (R = 83.14)

Example 11

Calculating the volume to be pumped off and the required volume flow rate at the intake port of the pumping station.

Molar mass of water
 $M_1 = 18 \text{ kg/kmol}$

Molar mass of air
 $M_2 = 29 \text{ kg/kmol}$

Vapor pressure of water
 $p_D \sim 23 \text{ mbar (at } 20^\circ \text{C)}$

Temperature ($T_C = 20^\circ \text{C}$)
 $T = 293 \text{ K}$

Pressure
(selected according to the diagram)
 $p = 10 \text{ mbar}$

Amount of water
 $Q_1 = 40 \text{ kg}$

Leaked air
 $Q_2 = 10 \text{ kg}$

$$V = R \frac{T}{p} \left(\frac{Q_1}{M_1} + \frac{Q_2}{M_2} + \dots \frac{Q_n}{M_n} \right) = [\text{m}^3]$$

Equation 28

Explanation:

Pressure p is assumed to be 10 mbar because at this pressure and at a temperature of 20°C water evaporates (see water vapor pressure curve in Figure 24).

$$V = 83.14 \frac{293}{10} \left(\frac{40}{18} + \frac{10}{29} \right)$$

$$V = 6253 \text{ m}^3$$

or $S = 6253 \text{ m}^3/\text{"time units"}$

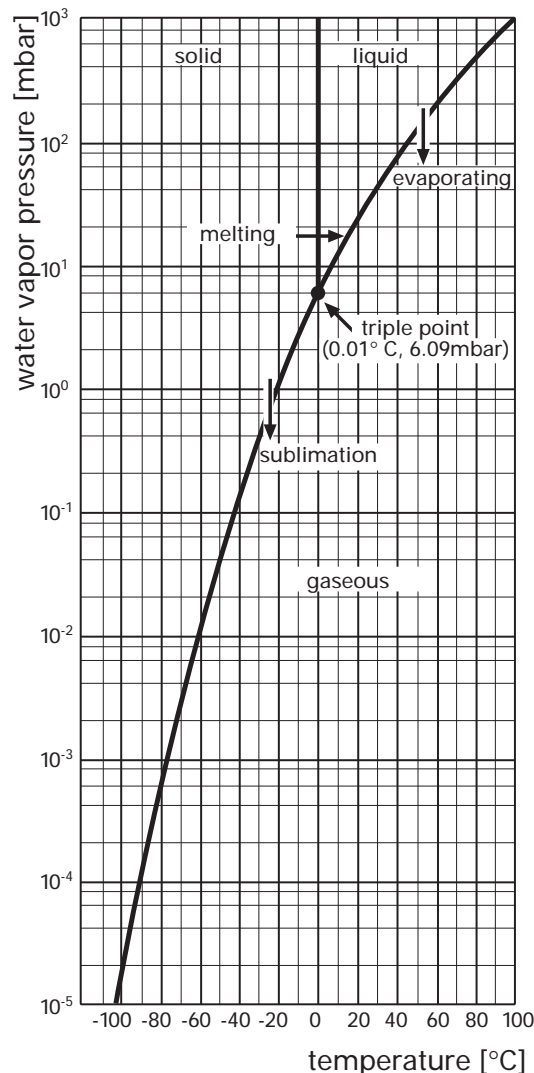

Fig. 24
Vapor pressure curve of water (for example 11).

7.8 Boyle-Mariotte Law

$$p \cdot V = \text{constant}$$

$$p_1 \cdot V_1 = p_2 \cdot V_2 \quad \text{at } T = \text{constant}$$

Equation 29

p_1 (mbar)
(Start/atmospheric) pressure

V_1 (m³)
Volume of gas at p_1

p_2 (mbar)
Pressure (in vacuum)

V_2 (m³)
Volume of gas at p_2

Example 12

$$p_1 = 1000 \text{ mbar}$$

$$V_1 = 1 \text{ m}^3$$

$$V_2 = ?$$

Variables p_2

a) $p_2 = 100 \text{ mbar}$

b) $p_2 = 10 \text{ mbar}$

c) $p_2 = 1 \text{ mbar}$

d) $p_2 = 0.1 \text{ mbar}$

$$\rightarrow V_2 = \frac{p_1 \cdot V_1}{p_2} = [\text{m}^3]$$

$$\text{a) } V_2 = \frac{1000 \text{ mbar} \cdot 1 \text{ m}^3}{100 \text{ mbar}} = 10 \text{ m}^3$$

$$\text{b) } V_2 = \frac{1000 \text{ mbar} \cdot 1 \text{ m}^3}{10 \text{ mbar}} = 100 \text{ m}^3$$

$$\text{c) } V_2 = \frac{1000 \text{ mbar} \cdot 1 \text{ m}^3}{1 \text{ mbar}} = 1000 \text{ m}^3$$

$$\text{d) } V_2 = \frac{1000 \text{ mbar} \cdot 1 \text{ m}^3}{0.1 \text{ mbar}} = 10000 \text{ m}^3$$

7.9 Selecting a Vacuum Pumping Station

A pumping station should be assembled for a particular vacuum process. Known parameters are:

vessel volume to be evacuated

$$V = 1.6 \text{ m}^3$$

required final pressure

$$p = 1 \cdot 10^{-3} \text{ mbar}$$

pump down time

$$t = 4 \text{ min} \triangleq 0.0\bar{6} \text{ h}$$

Calculating the required volume flow rate

$$t = \frac{V}{S} \cdot \ln \frac{p_1}{p_2} = [\text{m}^3/\text{h}]$$

t (h)
Pump down time

V (m³)
Volume of the recipient

S (m³/h)
Volume flow rate

p_1 (mbar)
(Start/atmospheric) pressure

p_2 (mbar)
(Working/final) pressure

$$S = \frac{V}{t} \cdot \ln \frac{p_1}{p_2} = [\text{m}^3/\text{h}]$$

$$S = \frac{1.6}{0.06} \cdot \ln \frac{1013}{0.001} = 332 \text{ m}^3/\text{h}$$

Selection of the vacuum pumping station

Explanation:

S is the constant required volume flow rate of the vacuum pumping station over the whole pressure range of 1013 mbar (atmospheric) to 1×10^{-3} mbar (Working/final pressure). On the basis of the preceding calculation, a WOD 412 B (Figure 25) is selected.

Checking the pump down time

$$t_1 = \frac{V}{S_v} \cdot \ln \frac{p_1 + \Delta p}{p_2 + \Delta p} = [\text{h}]$$

t (h)
Pump down time

V (m³)
Volume of the recipient

S_v (m³/h)
Volume flow rate of the backing pump

p₁ (mbar)
(Start/atmospheric) pressure p₁

p₂ (mbar)
(Compressed to) pressure p₂

Δp (mbar)
Differential pressure at the overflow valve

Caution!

Pressure p₂ (10 mbar) should be selected so that the overflow valve of the Roots vacuum pump (Δp = 53 mbar) is closed at the selected pressure Δp.

$$t_1 = \frac{1.6}{68} \cdot \ln \frac{1013 + 53}{10 + 53} = 0.0665 \text{ h}$$

$$t_1 = 0.0665 \text{ h} \Rightarrow t_1 = 4 \text{ min}^*$$

*) Based on the parameters, the pump down time for the vessel amounts to t = 4 min, that is, the volume flow rate of the backing pump (S = 68 m³/h) is so small that t₁ = t.

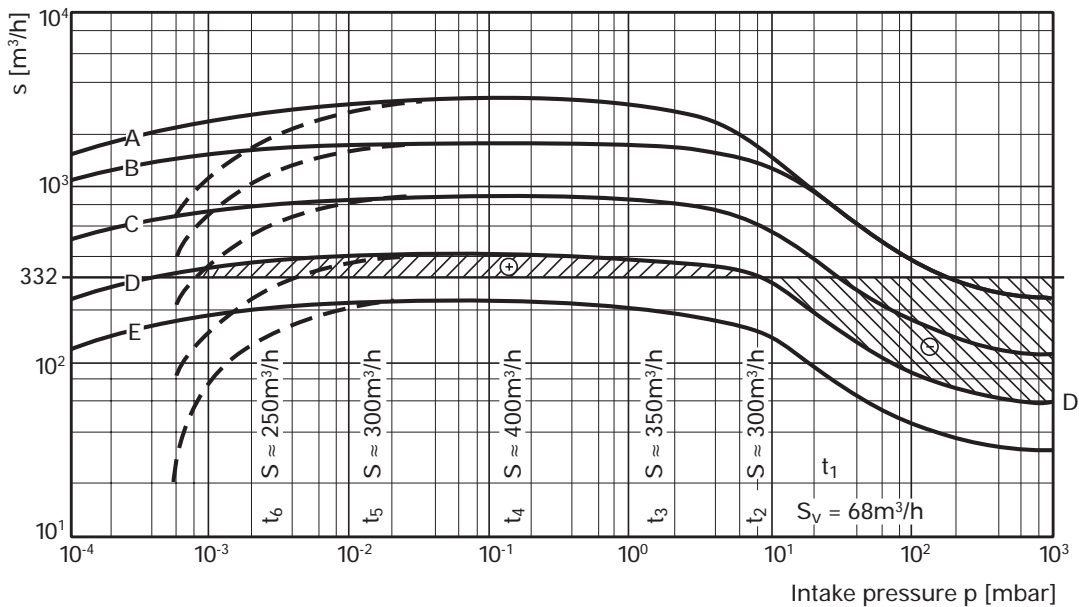

Fig. 25
Diagram for 7.9 (Selection of a pumping station)

— gas ballast valve of the backing pump closed.

----- gas ballast valve of the backing pump open

At 60 Hz operations, the volume flow rate increases by 20 %.

Volume flow rate

Roots vacuum pumps with two stages rotary vane vacuum pumps

A WOD 3000B

B WOD 1800 B

C WOD 900 B (WKP 1000 A/DUO 120)

D WOD 412 B (WKP 500 A/DUO 65)

E WOD 222 B

Calculations

$$t_1 = \frac{V}{S_m} \cdot \ln \frac{p_1}{p_2} = [\text{h}]$$

t (h)
Pump down time

V (m³)
Volume of the recipient

S_m (m³/h)
Mean volume flow rate of the pump station from pressure p₁ to p₂

p₁ (mbar)
(from) pressure p₁

p₂ (mbar)
(to) pressure p₂

$$t_2 = \frac{1.6}{300} \cdot \ln \frac{10}{4} = 0.0049 \text{ h}$$

$$t_3 = \frac{1.6}{350} \cdot \ln \frac{4}{1} = 0.0063 \text{ h}$$

$$t_4 = \frac{1.6}{400} \cdot \ln \frac{1}{0.02} = 0.0156 \text{ h}$$

$$t_5 = \frac{1.6}{300} \cdot \ln \frac{0.02}{0.004} = 0.0086 \text{ h}$$

$$t_6 = \frac{1.6}{250} \cdot \ln \frac{0.004}{0.001} = 0.0089 \text{ h}$$

Adding:

$$t_{\text{ges}} = t_1 + \dots + t_n$$

(Theoretical, calculable pump down time with the vacuum pumping station – WOD 412 B –)

$$\rightarrow t_{\text{ges}} = 0.1108 \text{ h} \rightarrow t_{\text{ges}} = 6.6 \text{ min}$$

$$[t_{\text{ges}} - t_1 = 6.6 - 4 = 2.6 \text{ min}]$$

Comparison

Required pump down time/theoretical, calculable pump down time

Required pump down time: t = 4 min

Calculated pump down time: t = 6.6 min

Selected vacuum pumping station

WOD 412 B:

WKP 500 A –

Nominal volume flow rate: S_{th} = 490 m³/h (see 8.9)

DUO 65 –

Nominal volume flow rate: S_{th} = 62 m³/h (see 8.8.3)

WOD 412 B is too small!

The pump down time is too long because the volume flow rate, especially that of the backing pump, is too small (t_{ges} = 6.6 min.).

WOD 900 B:

WKP 1000 A –

Nominal volume flow rate: S_{th} = 1070 m³/h

DUO 120 –

Nominal volume flow rate: S_{th} = 128 m³/h

WOD 900 B is right!

The volume flow rate is approx. twice that of the WOD 412 B and the pump down time therefore roughly halved.

t ~ 3.5 min. < 4 min.

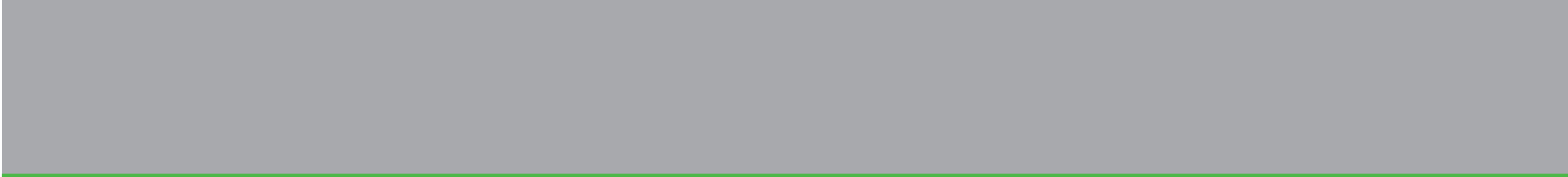

8 Appendix

8.1 Graphic Symbols in Vacuum Technology

The symbols for vacuum pumps are not position dependent. They can be turned in any direction. The higher pressure is on the narrower side.

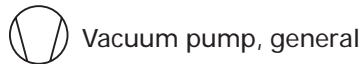

Vacuum pump, general

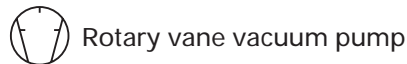

Rotary vane vacuum pump

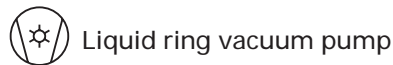

Liquid ring vacuum pump

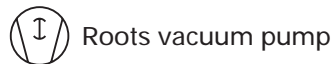

Roots vacuum pump

Vacuum pump accessories

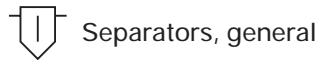

Separators, general

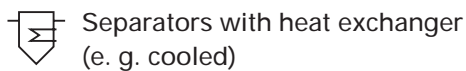

Separators with heat exchanger (e. g. cooled)

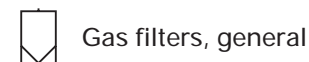

Gas filters, general

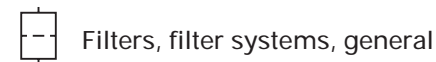

Filters, filter systems, general



Baffles, general

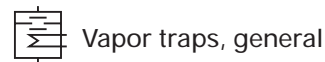

Vapor traps, general

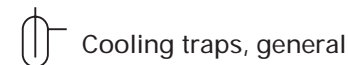

Cooling traps, general

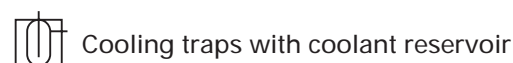

Cooling traps with coolant reservoir



Sorption traps

Vacuum gauges

With the exception of the symbols for throughput quantities, the symbols for vacuum gauges are position dependent. The point of the angle signifying vacuum must always be facing down.



Gauge head



Gauge operations and control unit

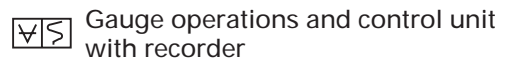

Gauge operations and control unit with recorder

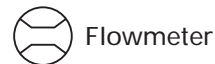

Flowmeter

Vacuum vessels

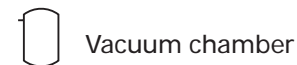

Vacuum chamber

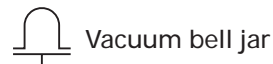

Vacuum bell jar

Shut-off devices

Symbols for shut-off devices are not position dependent. In flow diagrams, each attachment for connecting lines must be placed in the middle of the vertically drawn line. Symbols for angle valves must be entered in the diagram according to their actual position in the system.







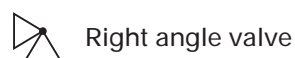

Shut-off device, general









Shut-off valve















Right angle valve

-  Stopcock
-  Three way Stopcock
-  Right angle Stopcock
-  Gate valve
-  Shut-off flap
-  Non-return valve
-  Safety shut-off device

Operation of shut-off devices

-  Manual drive
-  Dosing valve
-  Electromagnetic drive
-  Hydraulic or pneumatic drive
-  Electric motor drive
-  Weight driven

Pipe Connections

-  Flange connection
-  Flange connection, screwed
-  Small flange connection
-  Clamped flange connection
-  Threaded pipe connection
-  Ground-in ball and socket joint
-  Spigot and socket joint
-  Taper ground joint
-  Altering the diameter of the conducting pipe
-  Cross-over of two conducting pipes with connecting point
-  Cross-over of two conducting pipes without connecting point
-  Branch-off point

Directional signs

-  Vacuum

8.2 Definition of terms

A Absorption

Absorption is a type of sorption in which the gas (absorbate) diffuses into the bulk of the solid or liquid (adsorbent).

Adsorption

Adsorption is a type of sorption in which the gas (adsorbate) is retained at the surface of the solid or liquid (adsorbent).

B Backing pump

A backing pump generates the necessary low pressure required by the exhaust of some vacuum pumps.

C Compression chamber

The compression chamber is the space within the stator of some positive displacement pumps. It is the space where gas is compressed before being expelled.

Compression ratio

The compression ratio is the ratio between the outlet pressure and the inlet pressure of a pump for a specific gas.

Cooling trap

A cooling trap is a trap which affects condensation on a cooled surface.

D Desorption

Desorption is the movement of gases sorbed by a sorbent material. The movement can be spontaneous or can be accelerated by physical processes.

Diffusion

Gas diffusion is the movement of a gas in another medium owing to its concentration gradient. The medium may be gaseous, liquid or solid.

F Flow

Viscous flow

Viscous flow is the passage of a gas through a duct under conditions such that the mean free path is very small in comparison with the smallest internal dimension of a cross section of the duct. The

flow is therefore dependent on the viscosity of the gas and may be laminar or turbulent. In the case of viscous flow the resistance is a function of the pressure.

Turbulent flow

Turbulent flow (eddy flow) is a viscous flow with mixing motion above a critical Reynolds number (for circular cylindrical pipes $Re = 2300$).

Laminar flow

Laminar flow (parallel flow) is a viscous flow without mixing motion at small Reynolds numbers.

Molecular flow

Molecular flow is the passage of a gas through a duct under conditions such that the mean free path is very large in comparison with the largest internal dimensions of a cross section of the duct. In the case of molecular flow, the resistance is independent of the pressure.

Flow resistance

In most applications, the vacuum pump is connected to the chamber via a pipe. This pipe exhibits a flow resistance which arises from the ratio pressure differential Δp divided by the gas flow q . At high vacuum and ultra high vacuum, flow resistance is independent of the pressure. The unit is $s \cdot m^{-3}$, $s \cdot l^{-1}$.

Fore vacuum pressure

The fore vacuum pressure is the pressure required at the discharge side of a vacuum pump which cannot operate at atmospheric pressure.

G Gas

Gas is matter in which the mean distance between the molecules is large in comparison to their dimensions and the mutual arrangement of the individual molecules is constantly changing. Gas is a gaseous state which has not been converted into a liquid or solid state by compression at the prevailing temperature and pressure.

Gas ballast

Inlet of a controlled quantity of gas, usually into the compression chamber of a positive displacement pump, so as to prevent condensation within the pump.

Gas liberation

Gas liberation is spontaneous desorption.

Gas load

The gas load is the gas throughput delivered to a vacuum pump. The unit is mbar, l/s or sccm (standard cubic centimeters per minute). Standard conditions are 1013.25 mbar and 273.15 K (standard conditions).

At 20°C, 1 mbar l/s = 55.18 sccm.

Gettering

Gettering means bonding of gas, preferably by chemical reactions. Getters (getter materials) often have large real surfaces.

Knudsen number

The various types of flow are characterized by the ratio of the diameter of a pipe to the mean free path of the gas flowing through that pipe. This ratio is the Knudsen number

$$K_n = l/d.$$

Laminar flow

Laminar flow is a viscous flow without inter-mixing at small Reynolds number levels.

Leak

Leaks in a vacuum system are holes or voids in the walls or at joints, caused by faulty material or machining or incorrect handling of the seals.

Leak rate

The leak rate is the throughput of a gas through a leak. It is a function of the type of gas, pressure difference and temperature. The unit for the leak rate is:

$$1 \text{ Pa} \cdot \text{m}^3 \cdot \text{s}^{-1} = 1 \text{ W} = 10 \text{ mbar} \cdot \text{l} \cdot \text{s}^{-1}$$

Mass flow

Mass flow is the mass of a gas flowing through a cross section of a pipe in a given time and the time span. It is equivalent to throughput.

Mean free path

The mean free path is the average distance which a molecule travels between two successive collisions with other molecules.

Multi – stage vacuum pumps

Multi – stage vacuum pump refers to the sequential arrangement of pumping systems frequently located in a common housing and representing a constructive unit.

Normal conditions

Normal conditions refer to the established standard temperature and standard pressure of a solid, liquid or gaseous substance.

Normal temperature

$$T_n = 273,15 \text{ K} \quad \delta_n = 0 \text{ }^\circ\text{C}$$

Normal pressure

$$P_n = 101325 \text{ Pa} = 1013.25 \text{ mbar}$$

Occlusion

Occlusion is the presence of a gas volume in solid particles or liquids (bubbles). This can occur in rotary vane pumps when a large amount of gas is pumped through the oil reservoir.

Oil mist filter in vacuum pumps

An oil separator in a vacuum pump is a device on the exhaust side of positive displacement pumps to trap and, in some cases, to return vacuum pump oil to the vacuum pump. If oil in droplet forms is involved, the device is referred to as an oil mist separator or oil mist filter.

Outgassing

Outgassing is a spontaneous desorption.

P Partial pressure

The partial pressure is the pressure due to a specified gas or vapor component of a gaseous and/or vapor mixture.

Particle density

Particle density is the quotient from the number of particles contained in a given volume.

Permeation

Permeation is the passage of gas through a solid barrier or a liquid of finite thickness. Permeation involves diffusion and surface phenomena.

Pressure

The pressure of a gas on a boundary surface is the normal component of the force exerted by the gas on an area of a real surface divided by that area.

Pressure units

The legal pressure units are Pascal as the SI unit, abbreviation Pa, and bar as a special unit designation for 10^5 Pa.

$$1 \text{ Pa} = 1 \text{ Nm}^2$$

$$1 \text{ bar} = 1000 \text{ mbar} = 10^5 \text{ Nm}^{-2} = 10^5 \text{ Pa.}$$

The unit commonly used in vacuum technology is the millibar.

pV throughput

pV throughput is the quotient from the pV value of a gas which in a given time span flows through the cross section of a pump at the prevailing temperature and the time span.

pV value

The pV value is the product of the pressure and the volume of a specified volume of a gas at the prevailing temperature. If the pV value is to be used as a measure for the volume of substance or gas, this must be an ideal gas at a specified temperature.

R Reynolds number

Non-dimensional quantity

$$\text{Re} = \frac{\rho \cdot v \cdot l}{\eta}$$

ρ = density of fluid

v = average flow velocity

l = characteristic length
(e.g. pipe diameter)

η = dynamic viscosity

Re < 2300 : laminar flow

Re > 4000 : turbulent flow

S Saturation vapor pressure

The saturation vapor pressure is the pressure exerted by a vapor which is in thermodynamic equilibrium with one of its condensed phases at the prevailing temperature.

Sorption

Sorption is the attraction of a gas (sorbate) by a solid or a liquid (sorbent). Sorbents are also called sorption agents.

T Throughput rate

Throughput rate of a vacuum pump is the pV flow of the pumped gas. Units of throughput rate are

$$\text{m}^3 \cdot \text{s}^{-1}, \text{l} \cdot \text{s}^{-1}, \text{m}^3 \cdot \text{h}^{-1}.$$

Total pressure

The total pressure is the sum of all partial pressures present. This term is used in contexts where the shorter term "pressure" might not clearly distinguish between the individual partial pressure and their sum.

Trap

A trap is a device in which the partial pressure of an undesirable residue in a mixture of gas and/or vapors which is reduced by physical or chemical means.

U Ultimate pressure

Ultimate pressure is the value which the pressure approaches asymptotically in a vacuum pump.

V Vacuum pump oil

Vacuum pump oil is an oil used in oil sealed vacuum pumps to seal, cool and lubricate.

Vacuum pump separators

Separators, fitted either at the inlet or discharge side are devices to trap condensates which form in parts of the pump or vacuum lines when pumping vapors and solid substances.

Vane

The vane is a sliding component dividing the space (compression chamber) between the rotor and the stator in a positive displacement pump.

Vapor

Vapor is a substance in gas phase which is either in thermodynamic equilibrium with its liquid or solid phase (saturated vapor) or brought to thermal equilibrium by compression (condensed) at the prevailing temperature (unsaturated vapor). *Note:* In vacuum technology, the word "gas" has been loosely applied to both the noncondensable gas and the vapor, if a distinction is not required.

Vapor pressure

The vapor pressure is the partial pressure of the vapor.

Volume flow rate

The volume flow rate S is the average volume flow from a standardized test dome through the cross section of the pump's intake port.

Units for the volume flow rate are m^3s^{-1} , $\text{l} \cdot \text{s}^{-1}$, $\text{m}^3 \cdot \text{h}^{-1}$, $\text{Torr} \cdot \text{l} \cdot \text{s}^{-1}$

Vacuum ranges	mbar	particle density	mean free path (l)
rough vacuum (GV)	1000 – 1	$2.5 \cdot 10^{25} - 2.5 \cdot 10^{22} \text{ m}^{-3}$	$l \ll d$
medium vacuum (FV)	1 – 10^{-3}	$2.5 \cdot 10^{22} - 2.5 \cdot 10^{19} \text{ m}^{-3}$	$l \approx d$
high vacuum (HV)	$10^{-3} - 10^{-7}$	$2.5 \cdot 10^{19} - 2.5 \cdot 10^{15} \text{ m}^{-3}$	$l > d$
ultra high vacuum (UHV)	$< 10^{-7}$	$< 2.5 \cdot 10^{15} \text{ m}^{-3}$	$l \gg d$

Particle density figures are valid for a temperature of 20 °C.
 d = pipeline diameter

Volume throughput

The volume throughput is the quotient from the volume of a gas which flows through the cross-section of a pipe in a given time at a specific pressure and a specific temperature, and the time span itself.

W Water vapor capacity C_{W_0}

The water vapor capacity is the maximum volume of water per unit of time which a vacuum pump can continuously take in and discharge in the form of water vapor under ambient conditions of 20°C and 1013 mbar.

Water vapor compatibility p_{W_0}

Water vapor compatibility is the highest intake pressure under which a vacuum pump can deliver pure water vapor and not accumulate liquid water internally.

8.3 Operating medium

Description	Application ¹⁾	attainable final pressure (mbar) ²⁾	flash point (K)	density (g/cm ³)
P3 Mineral oil Viscosity ISO-VG 100. The core fraction of a paraffin based oil type with low vapor pressure, without additives.	Standard applications To pump off e.g.: Air, inert gases, noble gases, ammonia, weak-aggressive solvent fumes, hydrogen, silane.	10 ⁻³	537	0.8
F5 Perfluoropolyether Viscosity ISO-VG 100. A polymer compound with low molecular weight and the structure of perfluoridated polyethers. F5 is biologically inert.	To pump off Oxygen, ozone, halogens, uranium compounds, organic and inorganic solvents, HCL, BF3, HF, PH3 fluorine.	1 · 10 ⁻³	–	1.9
A555 Synthetic oil on ester-basis viscosity ISO-VG 100, high thermal, oxidative and chemical stability, excellent wear protection, high corrosion protection	application with high operating temperatures > 100°C	5 · 10 ⁻²	525	0.96
RL 68 S polyol ester viscosity ISO-VG 68	Refrigerating unit oil. For pumping out coolant circuits in refrigerating units	2 · 10 ⁻²	518	0.97

Table 4
Operating medium

¹⁾ Applications involving other chemicals/substances available on request.

²⁾ With two-stage rotary vane vacuum pump

8.4 Conversion Tables

8.4.1 Pressure Conversion Table

	mbar	bar	torr	Pa (Nm ⁻²)	atm	lbf in ⁻² PSI	kgf cm ⁻²	in Hg	mm Hg	in H ₂ O	mm H ₂ O
1 mbar =	1	1 · 10 ⁻³	0.75	10 ²	9.869 · 10 ⁻⁴	1.45 · 10 ⁻²	1.02 · 10 ⁻³	2.953 · 10 ⁻²	0.75	0.402	10.197
1 bar =	10 ³	1	7.5 · 10 ²	1 · 10 ³	0.987	14.5	1.02	29.53	7.5 · 10 ²	4.015 · 10 ²	1.02 · 10 ⁴
1 torr =	1.333	1.333 · 10 ⁻³	1	1.333 · 10 ²	1.316 · 10 ⁻³	1.934 · 10 ⁻²	1.36 · 10 ⁻³	1.36 · 10 ⁻²	1	0.535	13.59
1 Pa (Nm ⁻²) =	0.01	1 · 10 ⁻⁵	7.5 · 10 ⁻³	1	9.87 · 10 ⁻⁶	1.45 · 10 ⁻⁴	1.02 · 10 ⁻⁵	2.953 · 10 ⁻⁴	7.5 · 10 ⁻³	4.015 · 10 ⁻³	0.102
1 atm =	1.013 · 10 ³	1.013	7.6 · 10 ²	1.013 · 10 ⁵	1	14.7	1.033	29.92	7.6 · 10 ²	4.068 · 10 ²	1.033 · 10 ⁴
1 lbf in ⁻² PSI =	68.95	6.895 · 10 ⁻²	51.71	6.895 · 10 ³	6.805 · 10 ⁻²	1	7.03 · 10 ⁻²	2.036	51.71	27.68	7.03 · 10 ²
1 kgf cm ⁻² =	9.807 · 10 ²	0.981	7.356 · 10 ²	9.807 · 10 ⁴	0.968	14.22	1	28.96	7.356 · 10 ²	3.937 · 10 ²	10 ⁴
1 in Hg =	33.86	3.386 · 10 ⁻²	25.4	3.386 · 10 ³	3.342 · 10 ⁻²	0.491	3.453 · 10 ⁻²	1	25.4	13.6	3.45 · 10 ²
1 mm Hg =	1.333	1.333 · 10 ⁻³	1	1.333 · 10 ²	1.316 · 10 ⁻³	1.934 · 10 ⁻²	1.36 · 10 ⁻³	3.937 · 10 ⁻²	1	0.535	13.59
1 in H ₂ O =	2.491	2.491 · 10 ⁻³	1.868	2.491 · 10 ²	2.458 · 10 ⁻³	3.613 · 10 ⁻²	2.54 · 10 ⁻³	7.356 · 10 ⁻²	1.868	1	25.4
1 mm H ₂ O =	9.807 · 10 ⁻²	9.807 · 10 ⁻⁵	7.354 · 10 ⁻²	9.807	9.677 · 10 ⁻⁵	1.42 · 10 ⁻³	10 ⁻⁴	2.896 · 10 ⁻³	7.354 · 10 ⁻²	3.394 · 10 ⁻²	1

Table 5

also: 1 dyn cm⁻² = 0,1 Pa (Nm⁻²) = 10⁻³ mbar

8.4.2 Leak Rate Conversion Table

	mbar l/s ⁻¹	torr l/s ⁻¹	atm cm ³ s ⁻¹	lusec	atm ft ³ min ⁻¹	1 kg/h air (20 °C)
1 mbar l/s ⁻¹ =	1	0.75	0.987	7.5 · 10 ²	2.097 · 10 ⁻³	4.3 · 10 ⁻³
1 torr l/s ⁻¹ =	1.333	1	1.316	10 ³	2.795 · 10 ⁻³	5.7 · 10 ⁻³
1 atm cm ³ s ⁻¹ =	1.013	0.76	1	7.6 · 10 ²	2.12 · 10 ⁻³	4.3 · 10 ⁻³
1 lusec =	1.333 · 10 ⁻³	0.001	1.32 · 10 ⁻³	1	2.79 · 10 ⁻⁶	5.7 · 10 ⁻⁶
1 atm ft ³ min ⁻¹ =	4.78 · 10 ²	3.58 · 10 ²	4.72 · 10 ²	3.58 · 10 ⁵	1	-
1 kg/h air (20 °C) =	230	175	230	1.75 · 10 ⁻¹	-	1

Table 6

8.4.3 Volume Flow Rate

	l/s ⁻¹	l/min ⁻¹	ft ³ min ⁻¹	m ³ /h ⁻¹
1 l/s ⁻¹ =	1	60	2.12	3.60
1 l/min ⁻¹ =	0.0167	1	0.0353	0.06
1 ft ³ min ⁻¹ =	0.472	28.32	1	1.70
1 m ³ /h ⁻¹ =	0.278	16.67	0.5890	1

Table 7

Definition of the symbols

Pa	Pascal
N/mm ²	Newton per square millimeter
bar	Bar
mbar	Millibar
at	Technical atmosphere
kp/cm ²	Kilopond per square centimeter
mm /Ws	Millimeter water column
atm	Physical atmosphere
Torr	Torr
mmQs	Millimeter mercury
psi, lbf/in ²	English pound per square inch

Appendix

8.5 Data on Various Substances (Table 8)

Compound	Formula	Mol.- Weight mol	Standard Concentration kg/m ³	Melting point °C	Melting Temperature kJ/kg	Boiling Temperature °C	Evaporation Temperature kJ/kg	Temperature °C	Critical Data Pressure bar	Specific Weight kg/l
Helium	He	4.00	0.18	-270.7	3.52	-268.9	20.94	-267.9	2.38	0.065
Neon	Ne	20.18	0.90	-248.6	16.75	-246.1	104.70	-228.4	27.8	0.484
Argon	A	39.94	1.78	-189.3	29.31	-185.9	159.14	-117.6	52.3	0.531
Air		28.96	1.29	-213		-192.3	196.83	-140.7	38.4	0.310
Hydrogen	H ₂	2.02	0.09	-252.9	58.63	-252.8	460.66	-239.9	13.2	0.031
Nitrogen	N ₂	28.02	1.25	-210.5	25.75	-195.7	201.01	-147.1	32.5	0.311
Oxygen	O ₂	32.00	1.43	-218.8	13.82	-182.9	213.58	-118.0	50.5	0.441
Fluorine	F ₂	38.00	1.70	-220.0	37.69	-188.0	159.14	-129.0	55.0	0.573
Chlorine	Cl ₂	70.91	3.17	-100.5	188.45	-34.0	259.64	146.0	78.4	0.573
Hydrofluoric Acid	HF	20.01	0.98	- 83.1	228.65	19.9	1289.84	230.2		
Hydrochloric Acid	HCl	36.47	1.63	-111.2	56.12	-84.8	443.91	51.0	84.1	0.610
Hydrobromic Acid	HBr	80.92	3.64	- 87.0	30.99	-66.5	217.77	91.9	86.8	0.807
Hydrogen Iodide	HJ	127.93	5.79	- 51.0	23.03	-35.1	154.95	150.8	84.7	
Hydrocyanic Acid	HCN	27.03	(1.21)	- 14.2	311.57	25.7	975.76	183.5	54.8	0.195
Water	H ₂ O	18.02	0.77	0.00	332.51	100.00	2257.22	374.2	225.6	0.329
Hydrogen Sulfide	H ₂ S	34.08	1.54	- 85.6	69.52	-60.4	548.60	99.6	95.0	
Ammonia	NH ₃	17.03	0.77	- 77.9	339.31	-33.4	1369.41	132.4	115.0	0.235
Nitrous Oxide	NO	30.01	1.34	-163.5	77.06	-151.7	460.66	-92.0	67.2	0.520
Nitrous Oxide	N ₂ O	44.02	1.97	- 90.8	148.67	-88.7	376.90	35.4	74.2	0.459
Nitrogen Tetraoxide	N ₂ O ₄	92.02	(4.11)	- 11.2	159.14	21.1	414.59	158.2	103.3	0.507
Cyanogen	C ₂ N ₂	52.04	(2.32)	- 27.9	156.20	-21.2	448.09	126.5	60.1	
Carbon Monoxide	CO	28.01	1.25	-205.0	30.15	-191.6	217.77	-138.7	35.7	0.311
Carbon Dioxide	CO ₂	44.01	1.97	- 56.6	184.26	-78.2	573.73	31.0	75.3	0.468
Carbon Disulfide	CS ₂	76.13	(3.40)	-111.5	57.79	46.3	351.78	277.7	75.5	0.441
Sulfur Dioxide	SO ₂	64.06	2.92	- 75.5	116.84	-10.0	402.03	157.6	80.4	0.524
Sulfur Hexafluoride	SF ₆	146.06	(6.52)	- 50.7	34.34	-63.5	114.75			
Methyl Fluoride	CH ₃ F	34.03	1.52			-78.1	519.29	44.9	59.9	
Methylene Fluoride	CH ₂ F ₂	52.03	(2.32)			-52.0				
Fluoroform	CHF ₃	70.02	(3.13)	-160		-84.2	262.58			
Tetrafluoromethane	CF ₄	88.99	(3.93)	-183.6	7.96	-127.7	137.36	-45.5	38.1	0.618
Methyl Chloride	CH ₃ Cl	50.49	2.31	- 97.7	127.73	-23.7	427.16	141.5	68.0	0.353
Methylene Chloride	CH ₂ Cl ₂	84.94	(3.79)	- 96.7	54.44	40.1	329.58	237.5	62.9	
Chloroform	CHCl ₃	119.39	(5.33)	- 63.5	79.99	61.2	253.78	260.0	55.6	0.496
Difluorochloromethane	CHF ₂ Cl	86.48	(3.86)	-160		-40.8	247.08	96.0	50.3	
Fluorotrichloromethane	CHFCl ₂	102.93	(4.59)	-135		8.9	259.64	178.5	52.7	0.522
Trifluorochloromethane	CF ₃ Cl	104.47	(4.66)	-181		-81.5	150.76	28.7	39.4	
Difluorodichloromethane	CF ₂ Cl ₂	120.92	(5.40)	-155.0	34.34	-29.8	167.51	111.5	40.9	0.555
Fluorotrichloromethane	CHFCl ₂	137.38	(6.13)	-110.5	50.25	23.7	182.59	198.0	44.6	0.554
Ethyl Fluoride	C ₂ H ₅ F	48.06	(2.15)			-32.0			102.2	51.2
Ethyl Chloride	C ₂ H ₅ Cl	64.50	(2.88)	-136.4	69.10	12.4	382.35	187.2	54.3	0.330
Ethyl Bromide	C ₂ H ₅ Br	108.98	(4.86)	-118.7	54.02	38.4	280.58	230.8	63.5	0.507
Trifluoroethane	C ₂ F ₅ Cl	187.39	(8.37)	- 36.5		47.6	144.06	214.1	34.8	
Tetrafluoroethane	C ₂ F ₆	170.93	(7.63)	- 94.0		4.1	127.73	146.0		
Trifluorochloroethylene	C ₂ F ₃ Cl	116.48	(5.20)	-157.5		-27.9	195.15	107.0	40.3	0.575
Vinyl chloride	C ₂ H ₃ Cl	62.50	(2.79)	-159.7		-13.9	368.53			0.91
1,1-Dichloroethylene	C ₂ H ₂ Cl ₂	96.95	(4.33)	-122.5		31.7	272.21			
Trichloroethylene	C ₂ HCl ₃	131.40	(5.86)	- 86.4		87.2	242.05			
Tetrachloroethylene	C ₂ Cl ₄	165.85	(7.40)	- 22.4	62.82	120.8	209.39			
Fluorobenzene	C ₆ H ₅ F	96.10	(4.29)	- 41.9	108.46	84.8		286.5	46.1	0.354
Chlorobenzene	C ₆ H ₅ Cl	112.56	(5.02)	- 45.2	85.85	132.2	324.97	359.2	46.1	0.365
Benzyl chloride	C ₇ H ₇ Cl	126.58	(5.65)	- 39.2		179.4				
Methane	CH ₄	16.04	0.72	-182.5	58.63	-161.5	510.49	-81.5	47.1	0.162
Ethane	C ₂ H ₆	30.07	1.35	-183.3	92.97	-88.6	489.97	32.1	50.4	0.213
Propan	C ₃ H ₈	44.09	2.01	-187.7	79.99	-42.1	426.32	95.6	43.5	0.226
Butane	C ₄ H ₁₀	58.12	2.70	-138.4	77.47	-0.5	385.70	153.2	38.7	0.231
Pentane	C ₅ H ₁₂	72.14	3.45	-129.7	116.42	36.1	357.64	197.2	34.1	0.232
Hexane	C ₆ H ₁₄	86.17	(3.85)	- 95.3	147.83	68.7	335.02	234.5	30.6	0.233
Heptane	C ₇ H ₁₆	100.19	4.46	- 90.6	141.55	98.4	316.60	267.0	27.8	0.234
Octane	C ₈ H ₁₈	114.22	5.03	- 56.8	180.91	125.7	301.10	296.2	25.4	0.235
Benzene	C ₆ H ₆	78.11	(3.49)	5.5	127.73	80.1	394.49	288.1	49.5	0.304
Toluol	C ₇ H ₈	92.13	(4.11)	- 95	72.03	110.6	355.96	319.9	41.6	0.291
Ethylbenzene	C ₈ H ₁₀	106.16	(4.74)	- 94.9	86.27	136.2	339.63	344.0	38.0	0.284
o-Xyol	C ₈ H ₁₀	106.16	(4.74)	- 25.3	129.82	144.4	347.59	358.0	36.8	0.288
m-Xyol	C ₈ H ₁₀	106.16	(4.74)	- 47.9	108.88	139.2	343.40	349.0	35.9	0.282
p-Xyol	C ₈ H ₁₀	106.16	(4.74)	13.3	160.39	138.4	339.21	348.5	35.0	0.281
Styrolene (Beinyl Benzene)	C ₈ H ₈	104.14	(4.65)	- 30.6		145.2				
i-Propyl Benzene	C ₉ H ₁₂	120.19	(5.36)	- 96.0	80.82	152.4	312.83	362.7	32.2	
Diphenyl	C ₁₂ H ₁₀	154.20	(6.88)	70.5	121.45	256.1	309.90	495.6	32.9	0.343
Naphtalin	C ₁₀ H ₈	128.16	(5.72)	80.2	146.99	217.9	314.09	478.5	40.5	0.314
Methanol	CH ₃ O	32.04	(1.43)	- 97.6	103.02	64.7	1101.39	232.8	81.3	0.275
Aethanol	C ₂ H ₅ O	46.07	(2.06)	-114.2	108.05	78.3	845.94	234.3	64.4	0.276
Propanol	C ₃ H ₇ O	60.09	(2.68)	-126.1	86.69	97.2	753.80	265.8	51.8	0.273
Butanol	C ₄ H ₉ O	74.12	(3.31)	- 89.8	125.22	117.9	590.48	287.1	50.0	
Pentanol	C ₅ H ₁₁ O	88.14	(3.93)	- 78.9	111.81	137.8	515.10	315.0		
Hexanol	C ₆ H ₁₃ O	102.17	(4.56)	- 47.3	150.76	157.7	636.55			
Heptanol	C ₇ H ₁₅ O	116.19	(5.22)	- 34.3		175.8	439.72	365.3		
Octanol	C ₈ H ₁₇ O	130.22	(5.81)	- 16.7		195.2	410.40	385.5		
i-Propanol	C ₃ H ₇ O	60.09	(2.68)	- 89.5	89.20	82.3	670.05	273.5	54.9	
i-Butanol	C ₄ H ₉ O	74.12	(3.31)	-108.0	108.0	577.92	277.6	49.8		
i-Pentanol	C ₅ H ₁₁ O	88.14	(3.93)	-117.2	130.6	502.54	306.6			
Ethylene Glycol	C ₂ H ₄ O ₂	62.07	(2.77)	- 12.6	188.45	197.3	812.43			
1,3-Propylene Glycol	C ₃ H ₈ O ₂	76.09	(3.40)			214.2				
Glycerin	C ₃ H ₈ O ₃	92.09	(4.11)	- 18.0	200.60	290.0	825.00			
Benzyl Alcohol	C ₇ H ₈ O	108.13	(4.83)	- 15.3	82.92	205.4	466.94			
Phenol	C ₆ H ₆ O	94.11	(4.20)	40.9	120.61	182.20	510.91	419.2	62.5	
Formic Acid	CH ₂ O ₂	46.03	(2.05)	8.4	276.39	100.7	494.16			
Acetic Acid	C ₂ H ₄ O ₂	60.05	(2.68)	16.6	195.15	118.1	406.22	321.5	59.0	0.351
Monochloroacetic Acid	C ₂ H ₃ O ₂ Cl	94.50	(4.21)	61.3	205.20	189.5	265.93			
Dichloroacetic Acid	C ₂ H ₂ O ₂ Cl ₂	94.50	(4.21)	9.7	81.24	194.4	322.88			
Trichloroacetic Acid	C ₂ H ₁ O ₂ Cl ₃	94.50	(4.21)	57.0	62.40	195.6				
Ketene	C ₂ H ₂ O	42.04	(1.88)	-151.0		-56.0				
Acetone	C ₃ H ₆ O	58.08	(2.59)	- 94.8	96.32	56.2	523.48	235.0	48.6	0.252
Formaldehyde	CH ₂ O	30.03	(1.34)	- 92.0		-21.0	711.93			
Acetaldehyde	C ₂ H ₄ O	44.05	(1.97)	- 123.5	73.71	20.2	573.73	188.0		
Furfurol	C ₅ H ₄ O ₂	96.08	(4.29)	- 36.5		161.7	452.28			

Formula	Boiling Temperature at Various Pressure in °C								Specific Temperature of Vapors Under Constant Pressure Within Range of 0 - 1 bar kJ/kg °C				Dynamic viscosity of the Vapors in 10 ⁻² Pa.s						
	Pressure in mbar								Temperature in °C				Temperature in °C						
	1	5	10	20	40	100	200	500	1000	50	0	25	100	200	-50	0	25	100	200
He	-271.73	-271.54	-271.38	-271.18	-270.88	-270.45	-269.97	269.35	-268.9	5.20	5.20	5.20	5.20	5.20	1.66	1.89	2.01	2.34	2.75
Ne	-257.5	-255.9	-255	-254	-253	-251.5	-250.2	-248.2	-246.1	1.03	1.03	1.03	1.03	1.03	2.64	3.05	3.18	3.72	4.34
A	-218.9	-214.7	-212.1	-209.2	-206.2	-202	-197.8	-191.2	-185.9	0.52	0.52	0.52	0.52	0.52	1.83	2.16	2.32	2.76	3.27
									-192.3	1.01	1.01	1.01	1.01	1.02	1.49	1.74	1.87	2.22	2.64
H ₂	-263.4	-262	-261.4	-260.5	-259.7	-258	-256.4	-254.5	-252.8	13.51	14.05	14.34	14.41	14.41	0.744	0.856	0.908	1.05	1.23
N ₂	-226.8	-222.25	-220	-216.7	-215.2	-211	-207.4	-201.5	-195.7	1.04	1.04	1.04	1.04	1.05	1.44	1.69	1.81	2.12	2.51
O ₂	-220	-214.5	-212	-209	-205.5	-200.4	-196	-189.2	-182.9	0.91	0.91	0.91	0.93	0.96	1.66	1.96	2.09	2.49	2.96
F ₂	-223.9	-218.1	-215.3	-212.25	-209.7	-204.3	-200	-193.9	-188	0.80	0.82	0.82	0.86	0.90					
Cl ₂	-120	-108.8	-103.5	-96.7	-88.0	-75.5	-64.6	-48.1	-34	0.46	0.47	0.48	0.49	0.51	1.25	1.37	1.71	2.14	
HF (app.-96.3)	-78.5	-69.5	-60.0	-49.7	-33.5	-19.2	1.5	19.9				1.44	1.46	1.46					
HCl	-152.5	-142.6	-137.8	-132.4	-126.5	-117	-109	-96.2	-84.8		0.80	0.80	0.80	0.80	1.34	1.48	1.87	2.35	
HBr	-140.6	-129.7	-124.2	-118	-111.2	-101	-92.1	-79	-66.5	0.36	0.36	0.36	0.36	0.36		1.73	1.89	2.39	
HJ	-125.2	-112.2	-105.3	-98	-89.5	-76.5	-65.4	-49.5	-35.1	0.23	0.23	0.23	0.23	0.23	1.76	1.93	2.43	2.99	
HCN	-73.3	-58.2	-50.9	-43	-34.5	-22	-10.6	9	25.7	1.23	1.29	1.33	1.41	1.52	0.67	0.76	1.00	1.33	
H ₂ O	-20	-2.7	6.9	17.7	29.2	45.9	60	81.8	100		1.84	1.84	1.88	1.94		0.92	1.01	1.31	1.69
H ₂ S	-136	-124.7	-119	-112.5	-105.4	-95	-86.2	-72.8	-60.4	0.98	0.99	1.01	1.03	1.08	1.19	1.29	1.62		
NH ₃	-110.8	-99.6	-94.2	-88.5	-81.9	-72	-61.7	-46.5	-33.4	1.99	2.06	2.09	2.22	2.37	0.775	0.948	1.02	1.31	1.68
NO	-185.2	-181.2	-179.2	-176.5	-173.3	-167.9	-164	-157.3	-151.7	0.97	0.97	0.97	0.98	1.01	1.83	1.96	2.32	2.73	
N ₂ O	-144.8	-135.2	-130.7	-125.9	-120.7	-112.8	-106.3	-96.7	-88.7	0.82	0.86	0.88	0.95	1.02	1.39	1.52	1.87	2.29	
N ₂ O ₄	-57.6	-45	-39.2	-33	-26.6	-17.5	-8.8	7	21.1		0.82	0.86	0.95	1.05					
C ₂ H ₄	-97.8	-85.5	-79.5	-73	-65.8	-55.4	-46.4	-33.7	-21.2		1.07	1.10	1.17	1.17		0.948	1.02	1.29	
CO	-222.7	-218.2	-215.9	-213.6	-211.1	-207.1	-203.2	-196.9	-191.6	1.04	1.04	1.04	1.04	1.06	1.45	1.69	1.81	2.14	2.52
CO ₂	135.9	-126.3	-121.7	-116.5	-111.1	-102.9	-96	-86.4	-78.2	0.77	0.82	0.85	0.93	1.00	1.17	1.41	1.51	1.89	2.34
CS ₂	-76.7	-57.9	-48.9	-38.8	-27.5	-10.5	4.2	26.1	46.3	0.55	0.58	0.60	0.64	0.68	0.92	0.99	1.28	1.63	
SO ₂	-97.5	-85.4	-79.3	-72.7	-64.5	-51.3	-40.5	-24	-10		0.59	0.61	0.66	0.71	0.96	1.19	1.31	1.66	2.11
SF ₆	-134.5	-122.9	-117	-111.2	-104.5	-94.3	-86.3	-73.7	-63.5	0.50	0.60	0.64	0.75						
CH ₃ F	-148.9	-139.2	-133.8	-128.4	-122.1	-112.2	-103.6	-90.4	-78.1										
CH ₂ F ₂									-52			1.10	1.24	1.45					
CHF ₃									-84.2			0.84	0.96	1.11					
CF ₄	-186.5	-176.2	-171.4	-166.7	-161.1	-153.3	-146.5	-136.2	-127.7		0.72	0.76	0.87	1.00					
CH ₂ Cl	-102.5	-95.4	-88	-80	-67	-56	-39	-23.7			0.77	0.81	0.92	1.06	0.989	1.10	1.39	1.79	
CH ₂ Cl ₂	-72.6	-55.5	-47	-37.3	-26.7	-11.5	2.3	22.7	40.1	0.53	0.59	0.61	0.69	0.78	0.938	1.03	1.29	1.63	
CHCl ₃	-61	-42.5	-33.5	-23.2	-12	4.9	19.5	41	61.2		0.53	0.55	0.61	0.67	0.955	1.05	1.32	1.63	
CHFCl	-124.7	-112.6	-106.5	-99.5	-91.8	-80.4	-70.3	-54.7	-40.8	0.55	0.64	0.67	0.75	0.85	0.983	1.19	1.29	1.60	
CH ₂ FCl	-93.8	-78.5	-71	-62.2	-52.8	-38.6	-26.3	-7.5	8.9	0.50	0.57	0.59	0.67	0.74	0.923	1.08	1.15	1.39	
CF ₂ Cl	-151.1	-141.2	-136.2	-131	-124.7	-114.8	-106.2	-93.5	-81.5										
CF ₂ Cl ₂	-120.7	-107.3	-100.6	-93.2	-85.3	-72.8	-61.7	-45	-29.8	0.49	0.55	0.57	0.64	0.71	1.01	1.18	1.26	1.52	
CFCl ₃	-86.8	-70.8	-62.5	-53.8	-43.8	-28	-14.9	5.5	23.7	0.51	0.54	0.56	0.61	0.67	0.865	1.03	1.11	1.36	
C ₂ H ₂ F	-119.1	-106.5	-100.3	-93.3	-85.3	-73.3	-62.8	-46.8	-32										
C ₂ H ₂ Cl	-92.2	-77	-69.5	-60.7	-51.2	-36.8	-24.5	-5.3	12.4		1.27	1.31	1.47		0.955	1.05	1.32	1.63	
C ₂ H ₃ Br	-77	-60	-51.4	-41.8	-31.5	-15	-1.5	19.3	38.4		0.59	0.62	0.72	0.95					
C ₂ F ₃ Cl ₃	-70.9	-53	-44	-33.9	-23.2	-7.5	7	28.5	47.6	0.58	0.62	0.64	0.70		0.872	0.986	1.05	1.22	
C ₂ F ₂ Cl ₂	-97.9	-82.9	-75.5	-67	-58	-43.8	-31.9	-14	4.1	0.59	0.64	0.66	0.74		0.937	1.09	1.17	1.41	
C ₂ F ₃ Cl	-118	-105.2	-98.7	-91.5	-83.3	-71	-60	-43	-27.9										
C ₂ H ₃ Cl	-108	-93.7	-86.5	-79.1	-70.7	-57.5	-46.3	-29.1	-13.9		0.81	0.86	1.00	1.16					
C ₂ H ₂ Cl ₂	-80	-63.3	-55	-45.8	-35.5	-20.1	-6.7	13.5	31.7	0.67	0.71	0.80	0.89						
C ₂ HCl ₃	-46.8	-26.8	-16.8	-5.6	6.3	24.9	41	65.5	87.2		0.60	0.63	0.70	0.76					
C ₂ Cl ₄	-24	-2	8.8	21	34.5	54.2	72	98	120.8		0.58	0.60	0.64	0.69					
C ₂ H ₄ F	-46.5	-26.8	-16.8	-6	6.2	24.5	40	63.8	84.8										
C ₂ H ₄ Cl	-16.7	6	17.5	30	43.5	63.8	81.5	108.3	132.2										
C ₂ H ₃ Cl	18	43	55.5	69	84	106.3	125.6	154	179.4										
CH ₃	-206.9	-200.3	-197	-193.3	-189.4	-183.5	-178	-169.4	-161.5	2.07	2.17	2.23	2.45	2.81	0.862	1.04	1.12	1.36	1.64
C ₂ H ₆	-161.2	-150.7	-145.2	-139.3	-132.7	-122.8	-114	-100.7	-88.6	1.48	1.65	1.75	2.07	2.49	0.729	0.877	0.953	1.17	1.45
C ₃ H ₈	-130.9	-118.1	-111.5	-104.1	-96	-83.8	-73.1	-57	-42.1	1.31	1.55	1.67	2.02	2.46	0.632	0.765	0.831	1.03	1.28
C ₃ H ₁₀	-103.9	-88.7	-81	-72.7	-63.3	-49	-36.5	-17.8	-0.5	1.26	1.60	1.70	2.03	2.45	0.703	0.759	0.969		
C ₃ H ₁₂	-78.9	-65.1	-55.2	-44.3	-33.9	-17.7	-4.2	16.7	36.1	1.22	1.60	1.70	2.03	2.45	0.632	0.694	0.877	1.11	
C ₄ H ₁₄	-56.2	-38	-29	-18.6	-7.3	10	25	46.8	68.7	1.19	1.61	1.70	2.03	2.44	0.601	0.663	0.838	1.06	
C ₄ H ₁₈	-37.2	-16.7	-6.7	4.6	16.8	35.6	51.7	76	98.4	1.17	1.61	1.70	2.03	2.44		0.731	0.938		
C ₅ H ₁₆	-17.3	6	14.7	26.5	39.5	59	76.3	102	125.7	1.15	1.61	1.71	2.03	2.44		0.689	0.862		
C ₅ H ₁₈	-39.5	-22.8	-14.8	-6.3	3.3	20	35.5	58.7	80.1		0.95	1.05	1.34	1.68	0.714	0.826	0.970	1.22	
C ₆ H ₆	-30	-9	1.8	13.3	26.2	45.3	61.8	87.7	110.6		1.03	1.13	1.42	1.76		0.704	0.908	1.14	
C ₆ H ₈	-13.5	9.3	21	33.5	46.7	67.6	85.3	111.7	136.2		1.11	1.21	1.51	2.06					
C ₆ H ₁₀	-7.5	15.6	27	39.5	53.30	74	92	120	144.4		1.16	1.26	1.52	1.86					
C ₆ H ₁₂	-10.5	12.2	23.5	35.5	49.5	70	88	114.5	139.2		1.11	1.20	1.48	1.83					
C ₆ H ₁₄	-11.6	10.5	22.2	34.7	48.2	68.7	86.8	113.7	138.4		1.11	1.20	1.47	1.81					
C ₆ H ₁₆	-10.7	13.3	25.5	38.8	53.5	75	93.5	121	145.2		1.08	1.17	1.45	1.77					
C ₈ H ₁₂	-0.6	22	33.6	46	60	81	99	127	152.4		1.16	1.26	1.57	1.93					
C ₁₀ H ₁₂	65.8	96	110.5	127	144.5	171.1	194	227.2	256.1										
C ₁₀ H ₁₄	49.2	70	81	95	111.5	136.5	158	190	217.9										
CH ₃ O	-46.8	-28.9	-20	-10.5	0.3	16	29.8	48.2	64.7		1.34	1.41	1.60	1.84	0.887	0.975	1.24	1.59	
C ₂ H ₅ O	-34.7	-15.5	-6.4	3.5	14	29.5	42.5	61											

8.6 Desorption Rates on Clean Surfaces

Material	Surface-quality	Surface condition	Desorption rates ¹⁾		
			q_{Des} 1h	$\left[\frac{\text{mbar} \cdot \text{l}}{\text{s} \cdot \text{cm}^2} \right]$ 4h	10h
Stainless steel	blank	cleaned	$2.7 \cdot 10^{-7}$	$5.4 \cdot 10^{-8}$	$2.7 \cdot 10^{-8}$
Stainless steel	polished	cleaned	$2 \cdot 10^{-8}$	$4 \cdot 10^{-9}$	$2 \cdot 10^{-10}$
Stainless steel	pickled	heated for 1 hour,	$1.4 \cdot 10^{-9}$	$2.8 \cdot 10^{-10}$	$1.4 \cdot 10^{-10}$
Stainless steel	bead blasted	vented with normal air	$3 \cdot 10^{-10}$	$6.5 \cdot 10^{-11}$	$4 \cdot 10^{-11}$
Steel Ni plated	polished	cleaned	$2 \cdot 10^{-7}$	$1.5 \cdot 10^{-8}$	$5 \cdot 10^{-9}$
Steel Cr plated	polished	cleaned	$1.3 \cdot 10^{-8}$	$2.2 \cdot 10^{-9}$	$1.2 \cdot 10^{-9}$
Steel		rusted	$6 \cdot 10^{-7}$	$1.6 \cdot 10^{-7}$	$1 \cdot 10^{-7}$
Steel	blank	cleaned	$5 \cdot 10^{-7}$	$1 \cdot 10^{-7}$	$5 \cdot 10^{-8}$
Steel	bead blasted	cleaned	$4 \cdot 10^{-7}$	$8 \cdot 10^{-8}$	$3.8 \cdot 10^{-8}$
Aluminium		cleaned	$6 \cdot 10^{-8}$	$1.7 \cdot 10^{-8}$	$1.1 \cdot 10^{-8}$
Brass		cleaned	$1.6 \cdot 10^{-6}$	$5.6 \cdot 10^{-7}$	$4 \cdot 10^{-7}$
Copper		cleaned	$3.5 \cdot 10^{-7}$	$9.5 \cdot 10^{-8}$	$5.5 \cdot 10^{-8}$
Porcelain	glazed		$8.7 \cdot 10^{-7}$	$4 \cdot 10^{-7}$	$2.8 \cdot 10^{-7}$
Glass		cleaned	$4.5 \cdot 10^{-9}$	$1.1 \cdot 10^{-9}$	$5.5 \cdot 10^{-10}$
Acrylic glass			$1.6 \cdot 10^{-6}$	$5.6 \cdot 10^{-7}$	$4 \cdot 10^{-7}$
Neoprene			$4 \cdot 10^{-5}$	$2.2 \cdot 10^{-5}$	$1.5 \cdot 10^{-5}$
Perbunan			$4 \cdot 10^{-6}$	$1.7 \cdot 10^{-6}$	$1.3 \cdot 10^{-6}$
Viton			$1.2 \cdot 10^{-6}$	$3.6 \cdot 10^{-7}$	$2.2 \cdot 10^{-7}$
Viton		heated for 4 hours at 100 °C	$1.2 \cdot 10^{-7}$	$5 \cdot 10^{-8}$	$2.8 \cdot 10^{-8}$
Viton		heated for 4 hours at 150 °C	$1.2 \cdot 10^{-9}$	$3.3 \cdot 10^{-10}$	$2.5 \cdot 10^{-10}$
Teflon		degassed	$8 \cdot 10^{-7}$	$2.3 \cdot 10^{-7}$	$1.5 \cdot 10^{-7}$

Table 9
Desorption rates for clean surfaces

¹⁾ The desorption rates can be disproved by different types of pretreatment (e.g. annealing for hydrogen removal).

8.7 Correction Factor a

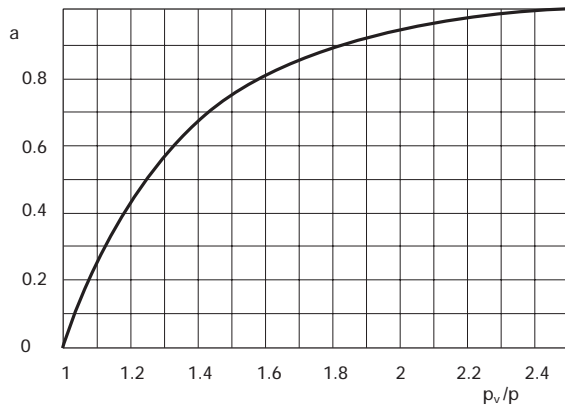

Fig. 26:
Correction Factor a
Calculation of the fore vacuum dependent volumetric efficiency rating for a Roots vacuum pump.

8.8 Technical Data, Rotary Vane Vacuum Pumps

8.8.1 Rotary Vane Vacuum Pumps UNO 2.5 and UNO 5

Single-stage		UNO 2.5	UNO 5 A
Connection nominal diameter			
Inlet		DN 16 ISO-KF	DN 16 ISO-KF
Outlet		DN 16 ISO-KF	DN 16 ISO-KF
Volume flow rate			
50 Hz	m ³ /h	2.5	4.6
60 Hz	m ³ /h	2.9	5.1
Ultimate pressure			
total without gas ballast	mbar	<5 · 10 ⁻²	<5 · 10 ⁻²
total with gas ballast	mbar	<1	<1
Water vapor tolerance	mbar	15	20
Water vapor capacity	g/h	37	75
Noise			
without gas ballast	dB(A)	53	53
with gas ballast	dB(A)	55	55
Operating temperature ¹⁾	°C	80	80
Operating medium quantity	l	0.45	0.45
Rotation speed			
50 Hz	rpm	2800	2800
60 Hz	rpm	3355	3355
Motor rating	kW	0.13	0.13
Weight	kg	10.2	11

8.8.2 Rotary Vane Vacuum Pumps UnoLine

Single-stage		UNO 35	UNO 65	UNO 120	UNO 250
Connection nominal diameter					
Inlet		DN 40 ISO-KF	DN 40 ISO-KF	DN 63 ISO	DN 100 ISO
Outlet		DN 40 ISO-KF	DN 40 ISO-KF	DN 63 ISO	DN 100 ISO
Volume flow rate					
50 Hz	m ³ /h	35	65	128	267
60 Hz	m ³ /h	42	72	154	320
Ultimate pressure					
total without gas ballast	mbar	<5 · 10 ⁻²	<5 · 10 ⁻²	<3 · 10 ⁻²	<3 · 10 ⁻²
total with gas ballast	mbar	<1	<1	<1	<1
Water vapor tolerance	mbar	30	30	33	33
Water vapor capacity	g/h	700	1400	3650	6950
Noise					
without gas ballast	dB(A)	54	54	58	60
with gas ballast	dB(A)	56	56	60	61
Operating temperature ¹⁾	°C	80	80	90	90
Operating medium	l	4.5	5.4	17	30
Motor rating					
50 Hz	kW	1.1	1.1	4	7.5
60 Hz	kW	1.3	1.3	4	7.5
Rated rotation speed pump					
50 Hz	rpm	1390	1390	965	960
60 Hz	rpm	1660	1660	1158	1152
Weight, with three-phase motor	kg	50	60	193	375

¹⁾ At ambient temperature 25 °C and operating medium P3, without gas ballast.

Data compilation

8.8.3 Rotary vane vacuum pumps DuoLine

Pump		DUO 2.5	DUO 35	DUO 65	DUO 120	DUO 250
Connection nominal diameter						
Inlet		DN 16 ISO-KF	DN 40 ISO-KF	DN 40 ISO-KF	DN 63 ISO-KF	DN 100 ISO-KF
Outlet		DN 16 ISO-KF	DN 40 ISO-KF	DN 40 ISO-KF	DN 63 ISO-KF	DN 100 ISO-KF
Volume flow rate						
50 Hz	m ³ /h	2.5	32	62	128	250
60 Hz	m ³ /h	2.9	38	70	154	300
Ultimate pressure						
total without gas ballast	mbar	<0.006	<0.003	<0.003	<0.003	<0.003
with gas ballast	mbar	<0.006	<0.005	<0.005	<0.006	<0.006
Water vapor tolerance	mbar	15	20	20	20	30
Water vapor capacity	g/h	37	500	1000	2300	4800
Noise						
without gas ballast	dB(A)	53	61	61	58	60
with gas ballast	dB(A)		64	62		
Operating temperature	°C	80	80	80	90	90
Operating medium quantity	l	0.4	3.2	4.2	13	23
Rotation speed						
50 Hz	rpm	2790	1390	1390	960	975
60 Hz	rpm	3280	1660	1660	1150	1175
Motor rating 50/60 Hz	kW	0.13/0.13	1.1/1.25	1.5/1.8	4	7.5
Weight	kg	10.3	56	65	215	410

8.8.4 Rotary vane vacuum pumps, Magnetic Coupled

Single-stage / Two-stage		DUO 5	DUO 10	DUO 20	UNO 30 M
Connection nominal diameter					
Inlet		DN 16 ISO-KF	DN 25 ISO-KF	DN 25 ISO-KF	DN 25 ISO-KF
Outlet		DN 16 ISO-KF	DN 25 ISO-KF	DN 25 ISO-KF	DN 25 ISO-KF
Volume flow rate					
50 Hz	m ³ /h	5	10	20	30
60 Hz	m ³ /h	6	12	24	35
Ultimate pressure					
total without gas ballast	mbar	<0.005	<0.005	<0.005	<0.08
with gas ballast	mbar	<0.02	<0.01	<0.01	<1
Water vapor tolerance	mbar	36	30	30	8
Water vapor capacity	g/h	230	230	460	190
Noise					
without gas ballast	dB(A)	55	55	57	60
with gas ballast	dB(A)				
Operating temperature	°C	80	80	85	80
Operating medium quantity	l	0.75	1	1.2	1.1
Rotation speed					
50 Hz	rpm	1390	1400	1390	1390
60 Hz	rpm	1620	1680	1620	1690
Motor rating 50/60 Hz	kW	0.25/0.37	0.45/0.55	0.55/0.65	0.75
Weight	kg	19	28	30	44

8.8.5 Rotary vane vacuum pumps PacLine

Pump		PAC 20	PAC 60	PAC 90	PAC 200	PAC 250	PAC 400	PAC 630
Connection nominal diameter								
Inlet		DN 25 ISO-KF	DN 40 ISO-KF	DN 40 ISO-KF	DN 63 ISO-F	DN 63 ISO-F	DN 100 ISO-F	DN 100 ISO-F
Outlet					DN G2"	DN G2"	DN 63 G 21/2"	DN 63 G 21/2"
Volume flow rate								
50 Hz	m ³ /h	18	54	81	180	230	400	600
60 Hz	m ³ /h		64	94	210	270	460	680
Ultimate pressure								
total without gas ballast	mbar	<2	<0.5	<0.5	<0.5	<0.5	<0.5	<0.5
Noise								
without gas ballast	dB(A)	70	70	75	80	80	80	80
Operating medium quantity	l	0.5	2	2	6	6	17	17
Rotation speed								
50 Hz	rpm	2800	1450	1450	1450	1450	960	975
60 Hz	rpm		1700	1700	1740	1740	1150	1170
Motor rating 50/60 Hz	KW	0.75	1.5/2.2	2.2/3	5.5/6.5	7.5/9	11/13.2	15/18
Weight	kg	20	58	76	170	185	420	540

8.8.6 Rotary vane vacuum pumps BA 251 and BA 501

Pump		BA 251	BA 501
Connection nominal diameter			
Inlet		DN 63 ISO-F	DN 100 ISO-F
Outlet		DN 63 ISO-F	DN 100 ISO-F
Nominal volume flow rate	m ³ /h	270	545
Volume flow rate at 50 Hz	m ³ /h	250	500
Ultimate pressure			
total without gas ballast	mbar	<6 · 10 ⁻²	<6 · 10 ⁻³
total with gas ballast	mbar	<6 · 10 ⁻¹	<6 · 10 ⁻¹
Water vapor tolerance	mbar	30	30
Water vapor capacity	kg/h	7	14
Noise			
without gas ballast	dB(A)	63	63
with gas ballast	dB(A)	65	65
Operating temperature	°C	80	80
Cooling water requirement	l/h	50	90
Operating medium quantity	l	17	45
Rotation speed	rpm	490	345
Motor rating	kW	11	15
Weight with motor	kg	570	1100

Data compilation

8.9 Technical data

8.9.1 Roots Vacuum Pumps WKP

Pumps		WKP 250 A	WKP 500 A	WKP 1000 A/AD	WKP 2000 A/AD
Nominal volume flow rate					
50 Hz	m ³ /h	270	490	1070	2065
60 Hz	m ³ /h	324	590	1284	2478
Starting pressure	mbar	1013	1013	1013	1013
Differential pressure at overflow valve	mbar	53	53	43	35
Leak rate					
Pump with radial shaft seals	mbar · l/s	<1 · 10 ⁻²	<1 · 10 ⁻²	<1 · 10 ⁻²	<1 · 10 ⁻²
Pump with canned motor	mbar · l/s	<1 · 10 ⁻⁵	<1 · 10 ⁻⁵	<1 · 10 ⁻⁵	<1 · 10 ⁻⁵
Rotation speed					
50 Hz	rpm	3000	3000	3000	3000
60 Hz	rpm	3600	3600	3600	3600
Motor rating					
50 Hz	kW	0.75	1.5	3	5.5
60 Hz	kW	1.1	2.2	4	7.5
Motor rating with canned motor					
50 Hz	kW	1.5	1.5	5	5.5
60 Hz	kW	1.7	1.7	5.7	5.7
Materials – rotor and casing		GGG/GGL	GGG/GGL	GGL(A) GGG/GGG 40.3 (AD)	GGG/GGL (A) GGG/GGG 40.3 (AD)
Oil filling	l	1.5	1.5	3	5
Weight with motor, approx.	kg	95	125	250	370

A: Standard pump with standard motor

AD: Pressure surge-protected model with

8.9.2 Roots Vacuum Pumps with magnetic coupling

WKP with magnetic coupling		500 AM/ADM	1000 AM/ADM	2000 AM/ADM	4000 AM/ADM	6000 AM/ADM
Nominal volume flow rate						
50 Hz	m ³ /h	490	1070	2065	4050	6070
60 Hz	m ³ /h	590	1284	2478	4860	7280
Starting pressure	mbar	1013	1013	1013	1013	1013
Differential pressure at overflow valve	mbar	53	43	35	25	20
Leak rate						
Pump with magnetic coupling	mbar · l/s	<1 · 10 ⁻⁵	<1 · 10 ⁻⁵	<1 · 10 ⁻⁵	<1 · 10 ⁻⁵	<1 · 10 ⁻⁵
Noise level (DIN 45635)	db(A)	70-75	72-75	72-75	74-79	74-79
Rotation speed						
50 Hz	rpm	2860	2860	2860	2900	2900
60 Hz	rpm	3430	3430	3430	3480	3480
Motor rating						
50 Hz	kW	1.5	3	5.5	11	15
60 Hz	kW	2.2	4	7.5	15	18.5
Operating medium quantity	l	1.5	3	5	6.8	6.8
Weight, pump						
Standard motor	approx. kg	130	250	380	630	850
Pump without motor	approx. kg	110	220	320	540	750

AM: Standard pump with magnetic coupling

ADM: Pressure surge-protected model with magnetic coupling

WKP 4000 A/AD	WKP 6000 A/AD	WKP 8000	WKP 12000	WKP 18000	WKP 25000
4050	6075	8000	12000	17850	25000
4860	7290	9600	12000	21420	25000
1013	1013	1013	1013	1013	1013
25	20	27	18	10	7
$<1 \cdot 10^{-2}$	$<1 \cdot 10^{-2}$	$<1 \cdot 10^{-2}$	$<1 \cdot 10^{-2}$	$<1 \cdot 10^{-2}$	$<1 \cdot 10^{-2}$
-	-	-	-	-	-
3000	3000	1500	2250	1500	2100
3600	3600	1800	2250	1800	2100
11	15	22	30	45	55
15	18.5	30	30	55	55
5.5					
5.7					
GGG/GGL (A)	GGG/GGL (A)	GGL	GGL	GGL	GGL
GGG/GGG 40.3 (AD)	GGG/GGG 40.3 (AD)				
5	6.8	21	21	68	68
380	850	1600	1950	3100	4000

8.9.3 Gas cooled Roots Vacuum Pumps WGK

Pumps		WGK 500	WGK 1500	WGK 4000	WGK 8000
Nominal volume flow rate					
50 Hz	m ³ /h	520	1500	4600	8000
60 Hz	m ³ /h	620	1800	5500	9600
Ultimate pressure	mbar	130	130	130	130
Maximum Motor rating	kw	18.5	2 x 30	132	200
Rotation speed					
50 Hz	rpm	3000	1500	1500	1500
60 Hz	rpm	3600	1800	1800	1800
Noise level ¹⁾	dB(A)	75 - 105	75 - 105	75 - 105	75 - 105
Noise frequency	Hz	200	100	100	100
Oil filling	l	3	5	21	21
Endplates heatable		Yes	Yes	No	No
Sealing gas connection		Yes	Yes	Yes	Yes
Materials					
Rotors and casing		GGG	GGG	GGG	GGG
Seals		Viton	Viton	Viton	Viton
Weight - Pump without drive					
Cooler and base frame	kg	116	520	1100	1500

¹⁾ These values depend on the operating pressure range or the differential pressure.

Data compilation

8.10 Technical Data Roots Vacuum Pumping Stations

8.10.1 Series WKD

	WKD 220	WKD 410	WKD 900	WKD 1800	WKD 3000	WKD 3500	WKD 6500
Volume flow rate at 10 ⁻¹ mbar							
50 Hz	m ³ /h 220	410	900	1800	3000	3500	6500
60 Hz	m ³ /h 265	490	1080	2160	3600	3900	7000
Pumping station components							
Roots vacuum pump	WKP 250 A	WKP 500 A	WKP 1000 A	WKP 2000 A	WKP 4000 A	WKP 4000 A	WKP 8000
Intermediate condenser	KS 0.2	KS 0.5	KS 0.5	KS 1.5	KS 1.5	KS 3.0	KS 6.0
Single-stage rotary vane vacuum pump	UNO 35	UNO 65	UNO 120	UNO 250	UNO 250	BA 501	BA 501
Total pressure							
without gas ballast	mbar 1 · 10 ⁻³	1 · 10 ⁻³	1 · 10 ⁻³	1 · 10 ⁻³	1 · 10 ⁻³	1 · 10 ⁻³	1 · 10 ⁻³
with gas ballast	mbar 2 · 10 ⁻²	2 · 10 ⁻²	2 · 10 ⁻²	2 · 10 ⁻²	2 · 10 ⁻²	2 · 10 ⁻²	2 · 10 ⁻²
Water vapor capacity	mbar 33	33	33	33	33	30	30
Installed motor rating ¹⁾							
50 Hz	kW 1.85	3.7	7	13	18.5	28.5	40.5
60 Hz	kW 2.2	4.4	8	15	22.5	33.5	48.5
Condenser cooling surface	0.2	0.5	0.5	1.5	1.5	3	6
Water cooling for backing pump	–	–	–	–	–	yes	yes
Cooling Water requirement ²⁾ rpm	4	10	10	30	30	62	122
Cooling water monitor in backing pump	–	–	–	–	–	yes	yes
Oil filling, complete	l 4.2	7.2	19	35	35	50	66
Weight	kg 260	290	570	1230	1410	2080	4000

8.10.2 Series WOD-A

	WOD 222 A	WOD 412 A	WOD 900 A	WOD 1800 A	WOD 3000 A	WOD 3500 A	WOD 6500 A
Volume flow rate at 10 ⁻¹ mbar							
50 Hz	m ³ /h 220	410	900	1800	3000	3500	6500
60 Hz	m ³ /h 265	490	1080	2160	3600	3900	7000
Pumping station components							
Roots vacuum pumps	WKP 250 A	WKP 500 A	WKP 1000 A	WKP 2000 A	WKP 4000 A	WKP 4000 A	WKP 8000
Single-stage rotary vane vacuum pumps	UNO 35	UNO 65	UNO 120	UNO 250	UNO 250	BA 501	BA 501
Total pressure							
without gas ballast	mbar 1 · 10 ⁻³	1 · 10 ⁻³	1 · 10 ⁻³	1 · 10 ⁻³	1 · 10 ⁻³	1 · 10 ⁻³	1 · 10 ⁻³
with gas ballast	mbar 2 · 10 ⁻²	2 · 10 ⁻²	2 · 10 ⁻²	2 · 10 ⁻²	2 · 10 ⁻²	2 · 10 ⁻²	2 · 10 ⁻²
Water vapor compatibility	mbar 33	33	33	33	33	30	30
Installed power output ¹⁾							
50 Hz	kW 1.85	3.7	7	13	18.5	28.5	40.5
60 Hz	kW 2.2	4.4	8	15	22.5	33.5	48.5
Air cooling	yes	yes	yes	yes	yes		
Water cooling	–	–	–	–	–	yes	yes
Cooling water requirement rpm	–	–	–	–	–	2	2
Cooling water monitor in backing pump	–	–	–	–	–	yes	yes
Oil filling, complete	l 4.2	7.2	19	35	35	50	66
Weight	kg 220	250	530	980	1180	1750	3650

¹⁾ Depending on the operating condition, the power input may be reduced by as much as 70%

²⁾ Inlet temperature max. 20 °C

8.10.3 Series WOD-B

		WOD 222 B	WOD 412 B	WOD 900 B	WOD 1800 B	WOD 3000 B
Volume flow rate at 10 ⁻¹ mbar						
50 Hz	m ³ /h	220	410	900	1800	3000
60 Hz	m ³ /h	265	490	1080	2160	3600
Pumping station components						
Roots vacuum pump		WKP 250 A	WKP 500 A	WKP 1000 A	WKP 2000 A	WKP 4000 A
Two-stage rotary vane vacuum pump		DUO 35	DUO 65	DUO 120	DUO 250	DUO 250
Total pressure						
without gas ballast	mbar	1 · 10 ⁻⁴	1 · 10 ⁻⁴	1 · 10 ⁻⁴	1 · 10 ⁻⁴	1 · 10 ⁻⁴
with gas ballast	mbar	1 · 10 ⁻⁴	1 · 10 ⁻⁴	1 · 10 ⁻⁴	1 · 10 ⁻⁴	1 · 10 ⁻⁴
Water vapor compatibility						
	mbar	20	20	20	30	30
Installed power output ¹⁾						
50 Hz	kW	1.85	3.7	7	13	18.5
60 Hz	kW	2.2	4.4	8	15	22.5
Air cooling		yes	yes	yes	yes	yes
Oil filling, complete	l	4.2	5.7	16	28	28
Weight	kg	220	250	530	980	1180

¹⁾ Depending on the operating condition, the power input may be reduced by as much as 70%.

9 Technical formulas

$$1 \quad p_{W0} = \frac{B}{S} \cdot \frac{1333 (p_s - p_a)}{1333 - p_s} \text{ [mbar]}$$

Water vapor tolerance (DSP)

$$2 \quad p_D = \frac{B}{S} \cdot \frac{p_v (p_{SD} - p_{AD})}{p_v - p_{SD}} + \frac{p_{SD} - p_L}{p_v - p_{SD}} \text{ [mbar]}$$

Tolerable inlet pressures for other vapors

$$3 \quad KB = FB \cdot \frac{T_A - T_B}{T_A - T_F}$$

Mixed operating fluid in the liquid ring vacuum pump

$$4 \quad S = R \cdot \frac{T_{Gas}}{p} \cdot \left(\frac{\dot{Q}_1}{M_1} + \frac{\dot{Q}_2}{M_2} + \dots + \frac{\dot{Q}_n}{M_n} \right) \text{ [m}^3\text{/h]}$$

Volume flow rate (pumping station)

$$5 \quad A = \frac{\dot{Q}_W}{k \cdot T_m} \text{ [m}^2\text{]}$$

Cooling surface (condenser)

$$6 \quad \dot{Q}_W = \dot{Q}_{H_2O} \cdot q_{H_2O} \left[\frac{\text{kJ}}{\text{h}} \right]$$

Condensation heat (condenser)

$$7 \quad T_m = \frac{\Delta T_{high} + \Delta T_{small}}{2} \text{ [K]}$$

Mean temperature differential (condenser)

$$8 \quad \Delta T_m = \frac{(T_{G in} - T_{W out}) - (T_{G out} - T_{W in})}{\ln \left(\frac{T_{G in} - T_{W out}}{T_{G out} - T_{W in}} \right)} \text{ [K]}$$

Mean temperature differential (heat exchanger)

$$9 \quad P = \frac{S_{th} \cdot \Delta p}{36000 \cdot \eta_{mech}} \text{ [kW]}$$

Power consumption (WKP/WGK)

$$10 \quad S = S_{th} \cdot \frac{K_m}{K_m + \frac{S_{th}}{S_v} - \left(\frac{S_v}{S_{th}} \right)^{1.5}} \text{ [m}^3\text{/h]}$$

Volume flow rate (WKP/WGK)

$$11 \quad p = \frac{S_v \cdot p_v}{S} \text{ [mbar]}$$

Intake pressure (WKP/WGK)

$$12 \quad S = S_{th} \cdot \left(1 - \frac{p_v}{p} \cdot \frac{a}{K_m} \right) \text{ [m}^3\text{/h]}$$

Volume flow rate (WKP/WGK)

$$13 \quad \frac{p_v}{p} = \leq 2.5 \rightarrow a = \frac{p_v^3 - p^3}{0.963 \cdot p_v^3} \text{ [mbar]}$$

Fore-vacuum/intake pressure (WKP/WGK)

$$14 \quad S = \frac{S_v \cdot (p + \Delta p)}{p} \text{ [m}^3\text{/h]}$$

Volume flow rate (WKP)

$$15 \quad \eta_{vol} = \frac{S}{S_{th}}$$

Volumetric efficiency rate (WKP/WGK)

$$16 \quad \eta_{vol} = \frac{K_m}{K_m + \frac{S_{th}}{S_v} - \left(\frac{S_v}{S_{th}} \right)^{1.5}}$$

Volumetric efficiency rate (WKP/WGK)

$$17 \quad L = \frac{3.6 \cdot r^3}{l} \cdot \left(0.039 \frac{r \cdot p_m}{\eta} + 30 \sqrt{\frac{T}{M}} \right) \text{ [m}^3\text{/h]}$$

Conductance value (universal)

$$18 \quad L = \frac{3.6 \cdot r^3}{l} (2150 \cdot r \cdot p_m + 95) \text{ [m}^3\text{/h]}$$

Conductance value (air at 20°C)

19

$$L = 7750 \frac{r^4 \cdot p_m}{l} \text{ [m}^3/\text{h]}$$

Conductance value air (laminar flow range 20°C)

28

$$V = R \frac{T}{p} \left(\frac{Q_1}{M_1} + \frac{Q_2}{M_2} + \dots \frac{Q_n}{M_n} \right) = \text{[m}^3\text{]}$$

(Gas)volume

20

$$L = 340 \frac{r^3}{l} \text{ [m}^3/\text{h]}$$

Conductance value air (molecular flow range 20°C)

29

$$p_1 \cdot V_1 = p_2 \cdot V_2 \quad \text{at } T = \text{constant}$$

Boyle-Mariotte law

21

$$L = \frac{1}{\frac{1}{L_1} + \frac{1}{L_2} + \frac{1}{L_3}} \text{ [m}^3/\text{h]}$$

Conductance value (in series)

22

$$L = L_1 + L_2 + L_3 \dots \text{ [m}^3/\text{h]}$$

Conductance value (parallel)

23

$$S_{\text{eff}} = \frac{1}{\frac{1}{L} + \frac{1}{S}} = \frac{L \cdot S}{L + S} \text{ [m}^3/\text{h]}$$

Volume flow rate (at the vacuum chamber)

24

$$p_{\text{eff}} = \frac{S \cdot p}{S_{\text{eff}}} \text{ [mbar]}$$

Pressure (at the vacuum chamber)

25

$$t = \frac{V}{S} \ln \frac{p_1}{p_2} \text{ [h]}$$

Pump down pressure (RPV/WKP/WGK)

26

$$t = \frac{V}{S} \ln \frac{p_1 + \Delta p}{p_2 + \Delta p} = \text{[h]}$$

Pump down pressure (WKP)

27

$$S_{\text{eff}} = \frac{3.6 \cdot q_L}{p} = \text{[m}^3/\text{h]}$$

Required volume flow rate (leak rate)

Technical formulas

Legend for the technical formulas

A	(m ²)	Cooling surface	p _{AD}	(mbar)	Partial pressure of the vapor-forming material in the atmospheric air
a		Correction factor a	p _D	(mbar)	Vapor compatibility
B	(m ³ /h)	Gas ballast volume	p _{eff}	(mbar)	Pressure at the end of the pipe
Δp	(mbar)	Set differential pressure on the overflow valve of the Roots vacuum pumps	p _L	(mbar)	Permanent gas-partial pressure at the intake port
ΔT _{high}	(K)	Highest pressure differential	p _m	(mbar)	Mean pressure = $\frac{p + p_{eff}}{2}$
ΔT _{small}	(K)	Smallest pressure differential	p _s	(mbar)	Saturated vapor pressure of the pumped water vapor at operating temperature
η	(Pa · s)	Tenacity of the gas	p _{SD}	(mbar)	Saturation vapor pressure at the operating temperature of the pump
η _{mech}		Mechanical efficiency rating of the pump (η ~ 0.85 for Roots vacuum pumps)	p _v	(mbar)	Fore-vacuum (counterpressure)
η _{vol}		Volumetric efficiency rating	p ₁	(mbar)	(Starting/atmospheric) pressure (to equation 29)
FB	(m ³ /h)	Operating liquid current	p ₂	(mbar)	Pressure (in vacuum)
k	$\left(\frac{\text{kJ}}{\text{h} \cdot \text{m}^2 \cdot \text{K}}\right)$	Heat transmission coefficient	p _{wo}	(mbar)	Water vapor tolerance as per PNEUROP
L	(m ³ /h)	Conductance value	Q̇	(kg/h)	Material component throughput per hour
KB	(m ³ /h)	Fresh liquid requirement in combined operation	Q	(kg)	Throughput of each component per flow rate
K _m		Maximum compression ratio of the Roots Vacuum Pump at p _v	Q̇ _{H₂O}	$\left(\frac{\text{kg}}{\text{h}}\right)$	Water vapor volume to be condensed per hour
l	(cm)	Pipe length	Q̇ _w	$\left(\frac{\text{kJ}}{\text{h}}\right)$	Condensation heat/volume per hour
M	(kg/kmol)	Molar mass	q _{H₂O}	$\left(\frac{\text{kJ}}{\text{kg}}\right)$	Evaporation heat
P	(kW)	Power consumption/ motor power	q _L	$\left(\frac{\text{mbar} \cdot \text{l}}{\text{s}}\right)$	Total leak rate (of the system)
p	(mbar)	(to equation 11) Intake pressure of the Roots vacuum pump	q _{pV}	S	Relationship of inflowing gas ballast quantity to the backing pump's capability
p	(mbar)	(to equation 24) Pressure at the beginning of the pipe	R	$\left(\frac{\text{mbar} \cdot \text{m}^3}{\text{kmol} \cdot \text{K}}\right)$	Universal gas constant R = 83.14
p	(mbar)	(Working) pressure	r	(cm)	Pipe radius
p _a	(mbar)	Water vapor partial pressure of the atmospheric air (value in practical operation p _a = 13 mbar)	S	(m ³ /h)	Volume flow rate

S_{eff}	(m ³ /h)	Volume flow rate at the end of the line (vacuum chamber)	T_S	(°C)	Boiling temperature of the evacuated material under pressure on the exhaust ports of the pump
S_{erf}	(m ³ /h)	Required volume flow rate of the pumping station at the vacuum chamber	$T_{W \text{ in}}$	(K)	Cooling water inlet temperature
S_{th}	(m ³ /h)	Theoretical volume flow rate of the Roots vacuum pump	$T_{W \text{ out}}$	(K)	Cooling water outlet temperature
S_V	(m ³ /h)	Volume flow rate of the backing pump (at pressure p_v)	T_m	(K)	Mean temperature differential between gas and cooling
T	(K)	Gas temperature	T_S	(K)	Boiling temperature under condensation pressure (in Example 1, page 22, $T_S = T_{S \text{ H}_2\text{O}}$)
T_A	(°C)	Temperature of the fed-back "revolving" operating liquid = emission temperature in the pump ports	t	(h)	Pump down time
T_B	(°C)	Operating temperature of the pump	V	(m ³)	Volume of the vacuum chamber
T_F	(°C)	Temperature of the fresh liquid of LRP	V	(m ³)	(to equation 25) (Gas) volume
T_{Gas}	(K)	Gas temperature	V_1	(m ³)	Volume of the gas with pressure p_1
$T_{\text{G out}}$	(K)	Gas outlet temperature	V_2	(m ³)	Volume of the gas with pressure p_2
$T_{\text{G in}}$	(K)	Gas inlet temperature			

Two columns of horizontal lines for writing, each containing 24 lines.

Rough and medium vacuum



Turbopumps



Dry vacuum pumps



Rotary vane vacuum pumps



Roots vacuum pumps



Diffusion vacuum pumps



Leak detectors



Valves



Installation parts



Vacuum gauges and control units



Gas analysis



Systems technology:
Coating and Leak Detection systems



Service

S [m³/h]

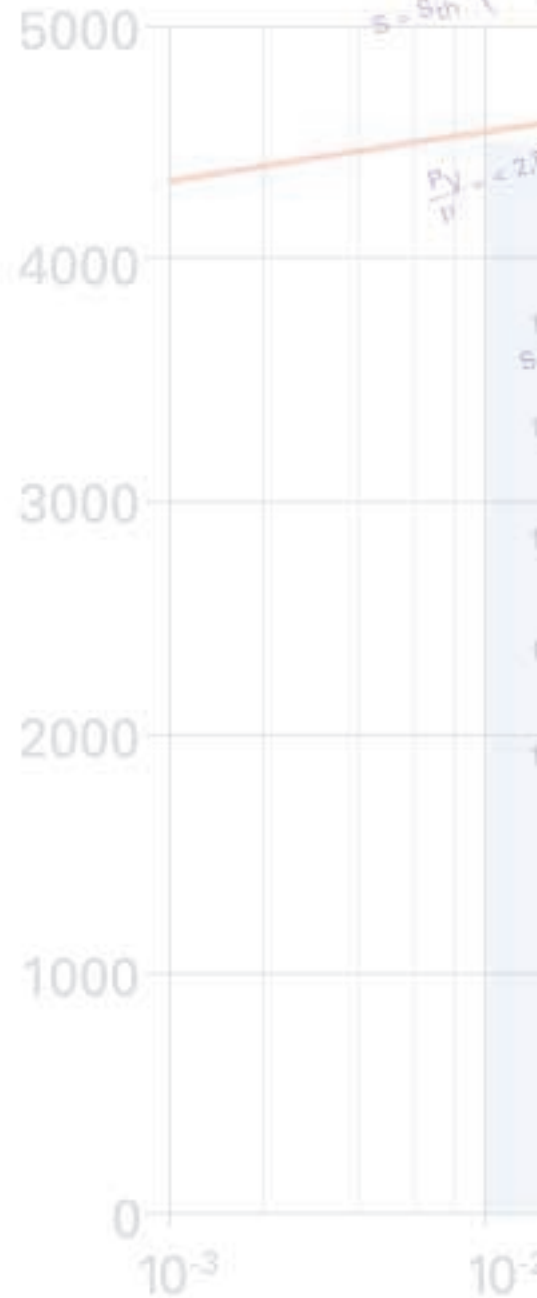

PFEIFFER  **VACUUM**

Pfeiffer Vacuum · Headquarters/Germany

Tel. +49-(0) 64 41-8 02-0 · Fax +49-(0) 64 41-8 02-2 02 · info@pfeiffer-vacuum.de · www.pfeiffer-vacuum.net